



**EN** Operating instructions. . . . . pages 1 to 12  
Original

**Content**

**1 About this document**

1.1 Function . . . . . 1

1.2 Target group: authorised qualified personnel. . . . . 1

1.3 Explanation of the symbols used . . . . . 1

1.4 Appropriate use . . . . . 1

1.5 General safety instructions . . . . . 1

1.6 Warning about misuse . . . . . 2

1.7 Exclusion of liability . . . . . 2

**2 Product description**

2.1 Ordering code . . . . . 2

2.2 Special versions. . . . . 2

2.3 Comprehensive quality insurance to 2006/42/EC . . . . . 2

2.4 Purpose . . . . . 2

2.5 Technical data . . . . . 3

2.6 Safety classification . . . . . 3

**3 Mounting**

3.1 General mounting instructions . . . . . 3

3.2 Dimensions . . . . . 4

**4 Electrical connection**

4.1 General information for electrical connection. . . . . 4

**5 Operating principles and latching force adjustment**

5.1 Mode of operation of the safety outputs. . . . . 5

5.2 Description of the latching force adjustment . . . . . 5

**6 Diagnostic functions**

6.1 Diagnostic-LEDs . . . . . 6

6.2 Solenoid interlock with conventional diagnostic output . . . . . 6

6.3 Solenoid interlock with serial diagnostic function. . . . . 8

**7 Set-up and maintenance**

7.1 Functional testing. . . . . 9

7.2 Maintenance . . . . . 9

**8 Disassembly and disposal**

8.1 Disassembly. . . . . 9

8.2 Disposal . . . . . 9

**9 Appendix**

9.1 Wiring examples . . . . . 10

9.2 Wiring configuration and connector accessories . . . . . 11

**10 EU Declaration of conformity**

**1. About this document**

**1.1 Function**

This operating instructions manual provides all the information you need for the mounting, set-up and commissioning to ensure the safe operation and disassembly of the safety switchgear. The operating instructions must be available in a legible condition and a complete version in the vicinity of the device.

**1.2 Target group: authorised qualified personnel**

All operations described in this operating instructions manual must be carried out by trained specialist personnel, authorised by the plant operator only.

Please make sure that you have read and understood these operating instructions and that you know all applicable legislations regarding occupational safety and accident prevention prior to installation and putting the component into operation.

The machine builder must carefully select the harmonised standards to be complied with as well as other technical specifications for the selection, mounting and integration of the components.

**1.3 Explanation of the symbols used**

 **Information, hint, note:**  
This symbol is used for identifying useful additional information.

 **Caution:** Failure to comply with this warning notice could lead to failures or malfunctions.  
**Warning:** Failure to comply with this warning notice could lead to physical injury and/or damage to the machine.

**1.4 Appropriate use**

The products described in these operating instructions are developed to execute safety-related functions as part of an entire plant or machine. It is the responsibility of the manufacturer of a machine or plant to ensure the correct functionality of the entire machine or plant.

The safety switchgear must be exclusively used in accordance with the versions listed below or for the applications authorised by the manufacturer. Detailed information regarding the range of applications can be found in the chapter "Product description".

**1.5 General safety instructions**

The user must observe the safety instructions in this operating instructions manual, labelled with the caution or warning symbol above, the country-specific installation standards as well as all prevailing safety regulations and accident prevention rules.

 Further technical information can be found in the Schmersal catalogues or in the online catalogue on the Internet: [products.schmersal.com](http://products.schmersal.com).

The information contained in this operating instructions manual is provided without liability and is subject to technical modifications.

There are no residual risks, provided that the safety instructions as well as the instructions regarding mounting, commissioning, operation and maintenance are observed.

### 1.6 Warning about misuse



In case of improper use or manipulation of the safety switchgear, personal hazards or damages to machinery or plant components cannot be excluded. The relevant requirements of the standard EN ISO 14119 must be observed.

### 1.7 Exclusion of liability

We shall accept no liability for damages and malfunctions resulting from defective mounting or failure to comply with this operating instructions manual. The manufacturer shall accept no liability for damages resulting from the use of unauthorised spare parts or accessories.

For safety reasons, invasive work on the device as well as arbitrary repairs, conversions and modifications to the device are strictly forbidden, the manufacturer shall accept no liability for damages resulting from such invasive work, arbitrary repairs, conversions and/or modifications to the device.

## 2. Product description

### 2.1 Ordering code

This operating instructions manual applies to the following types:

#### MZM 100 ① ②-③④⑤-A

No.	Option	Description
①		Solenoid interlock monitored 
	B	Actuator monitored
②	ST	Connector plug M23, (8+1)-pole
	ST2	Connector plug M12, 8-pole
③	1P2P	1 p-type diagnostic output and 2 p-type safety outputs (only in connection with "Solenoid interlock monitored")
	1P2PW	Similar to -1P2P, combined diagnostic signal guard door closed and solenoid interlock locked (only in connection with "Solenoid interlock monitored")
	1P2PW2	Similar to -1P2P, combined diagnostic signal guard door closed and can be locked (only in connection with "Actuator monitored")
	SD2P	Serial diagnostic output and 2 p-type safety outputs
④		Without latching (only in connection with "Solenoid interlock monitored")
	R	Electrical latching force, typically 30 N
	RE	Adjustable latching force, typically 30 ... 100 N
⑤	M	Permanent magnet, typically 15 N

**MZM 100-B1.1** | Actuator

### 2.2 Special versions

For special versions, which are not listed in the order code below 2.1, these specifications apply accordingly, provided that they correspond to the standard version.

### 2.3 Comprehensive quality insurance to 2006/42/EC

Schmersal is a certified company to appendix X of the Machinery Directive. As a result, Schmersal is entitled to autonomously conduct the conformity assessment procedure for the products listed in Appendix IV of the MD without involving a notified body. The prototype test certificates are available upon request or can be downloaded from the Internet at [www.schmersal.com](http://www.schmersal.com).

### 2.4 Purpose



The safety switchgears are classified according to EN ISO 14119 as type 4 interlocking devices.

The MZM 100 is designed for application in safety circuits and is used for monitoring the position of movable separating safety guards. A door detection sensor monitors the closed condition of the safety guard. The optional variable latching force is activated by the detection of the actuator when the safety guard is closed. The latching force exercised by the permanent magnet keeps the safety guard closed, also in de-energised condition (approx. 15 N).

The different variants can be used as safety switch with interlocking function either as solenoid interlock.



If the risk analysis indicates the use of a monitored interlock then a variant with the monitored interlock is to be used, marked with the symbol  in the ordering code. The actuator monitoring variant (B) is a safety switch with an interlock function for process protection.

The safety function of MZM 100 variant "Solenoid interlock monitored" consists of safely monitoring a magnetic interlocking force for a safety guard, safely switching off the safety outputs when the magnetic force drops below a defined magnetic force and maintaining the safe switched off condition of the safety outputs for as long as the safety guard is open or unlocked.

The safety function of MZM 100 B variant "Actuator monitored" consists of safely switching off the safety outputs when the safety guard is opened and maintaining the safe switched off condition of the safety outputs for as long as the safety guard is open.



Interlocks with power to lock principle may only be used in special cases after a thorough evaluation of the accident risk, since the safety guard can be opened immediately on failure of the power supply or upon activation of the main switch.

### Series-wiring

Series-wiring can be set up. Response and risk times remain unchanged by series-wiring. The quantity of devices is only limited by the cable drops and the external cable fuse protection, according to the technical data.

In devices with the serial diagnostics function (ordering suffix -SD), the serial diagnostics connections are wired in series and connected to a SD Gateway for evaluation purposes. Up to 31 components can be wired in series.

Wiring examples for series-wiring, refer to appendix



The user must evaluate and design the safety chain in accordance with the relevant standards and the required safety level. If multiple safety sensors are involved in the same safety function, the PFH values of the individual components must be added.



The entire concept of the control system, in which the safety component is integrated, must be validated to the relevant standards.

**2.5 Technical data**

**General data:**

Standards:	EN 60947-5-3, EN ISO 14119, EN ISO 13849-1, IEC 61508
Material of the housings:	Plastic, glass-fibre reinforced thermoplastic, self-extinguishing
Working principle:	inductive
Coding level according to EN ISO 14119:	low
Response time:	≤ 150 ms
Duration of risk:	< 150 ms
Time to readiness:	< 4,000 s
Actuator:	MZM 100-B1.1
Series-wiring:	Unlimited
number of components, please observe external cable protection, max. 31 components in case of serial diagnostics	
Length of the sensor chain:	max. 200 m
- Note: Cable length and cable section alter the voltage drop depending on the output current	

**Mechanical data:**

Execution of the electrical connection:	
- ST:	M23 connector, (8+1) poles,
- ST2:	M12 connector, 8 poles
Tightening torque of the fixing screws:	8 Nm
Electrically adjustable latching force (RE), typically:	30 N ... 100 N
Permanent magnet (M), typically:	15 N
Holding force $F_{max}$ typically:	750 N
Holding force $F_{guaranteed}$ :	500 N
Mechanical life:	≥ 1,000,000 operations (for safety guards ≤ 5 kg and actuating speed ≤ 0.5 m/s)

**Switching distances to EN 60947-5-3:**

Assured switching distance $s_{ao}$ :	0 mm
Assured switch-off distance $s_{ar}$ :	1 mm

**Ambient conditions:**

Ambient temperature:	-25 °C ... +55 °C
Storage and transport temperature:	-25 °C ... +70 °C
Relative humidity:	30% ... 95%, no condensation, no icing

Degree of protection:	IP65 / IP67 to EN 60529
Installation altitude above sea level:	≤ 2,000 m
Protection class:	III
Resistance to shock:	30 g / 11 ms
Switching frequency:	≤ 1 Hz
Resistance to vibration:	10 ... 150 Hz, amplitude 0.35 mm / 5 g

**Insulation values to EN 60664-1:**

- Rated insulation voltage $U_i$ :	32 VDC
- Rated impulse withstand voltage $U_{imp}$ :	0.8 kV
- Over-voltage category:	III
- Degree of pollution:	3

**Electrical data:**

Operating voltage $U_B$ :	24 VDC -15% / +10% (stabilised PELV units to EN 60204-1)
No-load supply current $I_0$ :	max. 0.6 A
- Note:	plus current through the safety outputs
Rated operating voltage $U_g$ :	24 VDC
Rated operating current $I_g$ :	1 A
Required rated short-circuit current:	100 A
External cable and device fuse rating:	2 A gG

**Electrical data – Safety inputs:**

Safety inputs:	X1 and X2
Switching thresholds:	- 3 V ... 5 V (Low), 15 V ... 30 V (High)
Accepted test pulse duration on input signal:	≤ 1.0 ms
- With test pulse interval of:	≥ 100 ms
Classification:	ZVEI CB24I
Sink:	C1
Source:	C1 C2 C3

**Electrical data – Safety outputs:**

Safety outputs:	Y1 and Y2
Switching elements:	normally open function, 2 channel, OSSD, p-type
Fuse rating:	short-circuit proof
Utilisation category:	DC-13
- Rated operating voltage $U_g$ :	24 VDC
- Rated operating current $I_g$ :	each max. 0.25 A
Leakage current $I_l$ :	≤ 0.5 mA
Voltage drop $U_d$ :	≤ 1 V
Test pulse duration:	≤ 1.0 ms
Test pulse interval:	1,000 ms
Classification:	ZVEI CB24I
Source:	C1
Sink:	C1

**Electrical data – Diagnostic output:**

Diagnostic output:	OUT
Switching element:	p-type, short-circuit proof
Utilisation category:	DC-13
- Rated operating voltage $U_g$ :	24 VDC
- Rated operating current $I_g$ :	max. 0.05 A
Voltage drop $U_d$ :	≤ 2 V
Wiring capacitance for serial diagnostics:	max. 50 nF

**Electrical data – Magnet control:**

Magnet control:	IN
Switching thresholds:	- 3 V ... 5 V (Low), 15 V ... 30 V (High)
Current consumption per input:	typical 10 mA / 24 V, dynamic 20 mA
Magnet switch-on time:	100 %
Accepted test pulse duration on input signal:	≤ 5.0 ms
- With test pulse interval of:	≥ 40 ms
Classification:	ZVEI CB24I
Sink:	C0
Source:	C1 C2 C3



Use isolated power supply only. If the cable and connector assembly is not listed for Type 12 or higher, then the device shall be used in a Type 1 environment only.

**2.6 Safety classification**

Standards:	EN ISO 13849-1, IEC 61508
PL:	up to e
Control Category:	4
PFH:	$3.54 \times 10^{-9}$ / h
SIL:	suitable for SIL 3 applications
Mission time:	20 years

**3. Mounting**

**3.1 General mounting instructions**



Please observe the remarks of the standards EN ISO 12100, EN ISO 14119 and EN ISO 14120.



The solenoid interlock must be used as an end stop.

Any mounting position. The system must only be operated with an angle of ≤ 2° between the solenoid interlock and the actuator. For fitting the solenoid interlock and the actuator, two mounting holes for M6 screws with washers (washers included in delivery) are provided.

After fitting, the mounting holes can be sealed by means of the supplied plugs. The plugs serve as a means of sealing the assembly openings and are also suitable to prevent against tampering with the screw connection.

Minimum distance between two devices: 100 mm



The actuator must be permanently fitted to the safety guards and protected against displacement by suitable measures (e.g. tamperproof screws, gluing, drilling of the screw heads).



At an ambient temperature of  $\geq 50\text{ }^{\circ}\text{C}$ , the safety component must be fitted so that it is protected against unintentional contact with persons.



The safety component must be operated in the operating direction of the latching force (refer to image).

### Axial misalignment and operating direction of the latching force

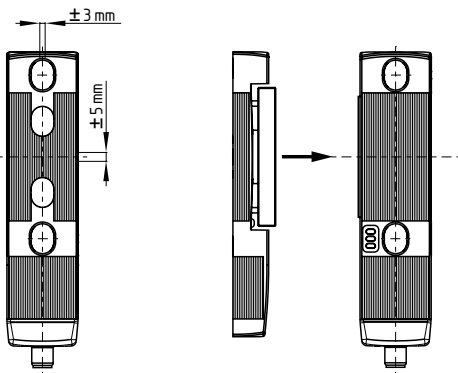

### 3.2 Dimensions

All measurements in mm.

#### Solenoid interlock

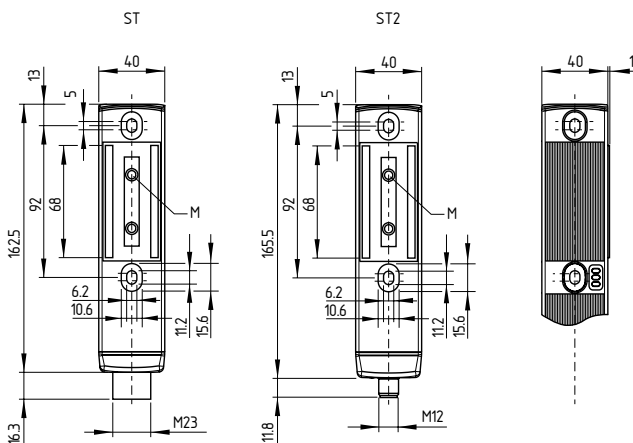

#### Actuator

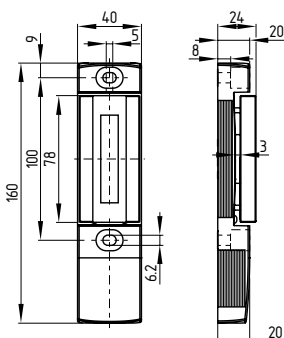

#### Key

M Permanent magnet

## 4. Electrical connection

### 4.1 General information for electrical connection



The electrical connection may only be carried out by authorised personnel in a de-energised condition.

The voltage inputs A1, X1, X2 and IN must have a protection against permanent overvoltage. supply units according to EN 60204-1 is recommended.

The required electrical cable and device fuse protection must be integrated in the installation.

The safety outputs can be integrated into the safety circuit of the control system. For applications of PL e / control category 4 to EN ISO 13849-1, the safety outputs of the safety switchgear or the chain of components must be connected to a safety-monitoring module of the same category.

#### Requirements for the connected safety-monitoring module:

- Dual-channel safety input, suitable for 2 p-type semi-conductor outputs
- Digital inputs to EN 61131-2, Table "Standard operating ranges for digital inputs (current sinking)"
- Test function

The safety-monitoring module must tolerate internal functional tests of the solenoid interlock with cyclic switch-off of the safety outputs for max. 2 ms (typically < 1 ms). The switch-off stage of the test cycle is temporarily reduced by an active ohmic discharge of the cable.



If the safety sensor is connected to electronic safety-monitoring modules, we recommend that you set a discrepancy time of min. 100 ms. The safety inputs of the safety-monitoring module must be able to blank a test impulse of approx. 1 ms. The safety-monitoring module does not need to have a cross-wire short monitoring function, if necessary, the cross-wire short monitoring function must be disabled.



Information for the selection of suitable safety-monitoring modules can be found in the Schmersal catalogues or in the online catalogue on the Internet: [products.schmersal.com](http://products.schmersal.com).

If the solenoid interlock is wired to relays or to non-safety relevant control components, a new risk analysis must be carried out.

#### Cable design in case of serial diagnostics



On wiring SD devices, pay attention to the voltage drop on the cables and the current carrying capacity of the individual components.

The wiring capacity of the connecting cable of the solenoid interlock must not exceed 50 nF. Depending on the strand structure, normal unshielded 30 m long control cables LIYY 0.25 mm<sup>2</sup> to 1.5 mm<sup>2</sup> have a wiring capacitance of approx. 3 ... 7 nF.



#### Accessories for the series-wiring

For convenient wiring and series-wiring of SD components, the SD junction boxes PFB-SD-4M12-SD (variant for the field) and PDM-SD-4CC-SD (variant for control cabinet on carrier rail) are available along with additional comprehensive accessories. Detailed information available on the internet at [products.schmersal.com](http://products.schmersal.com).

5. Operating principles and latching force adjustment

5.1 Mode of operation of the safety outputs  
- of MZM 100 variant "Solenoid interlock monitored"

The safety outputs are enabled, when the following conditions are met:

- the actuator has been detected and
- the interlock is locked, the magnetic force is > 500 N

The unlocking of the solenoid interlock causes the safety outputs to be disabled within the risk time. As long as the actuator is present on the solenoid interlock, the unlocked solenoid interlock can be locked again. In that case, the safety outputs are re-enabled.

The latching force F is permanently measured and checked. In this way, soiling of the solenoid interlock can be detected. If the latching force drops below 500 N, the release signal for the safety outputs Y1 / Y2 is not given.

- of MZM 100 B variant "Actuator monitored"

The safety outputs are enabled, when the following conditions are met:

- the actuator has been detected, the latching force is active and
- locking with magnetic force > 500 N possible

Due to the permanent monitoring of the closed magnetic circuit, the safety outputs Y1/Y2 are only enabled during the latching, when the magnetic circuit is properly closed and the latching force can also be obtained when activated. If the metal surfaces are soiled or damaged, the enabling signal is not transmitted.

The unlocking of the MZM 100 B does not lead to a switch-off.



**Violent separation of solenoid interlock and actuator (only in connection with "Solenoid interlock monitored")**

The solenoid interlock has a latching force F of 500 N. When the actuator and the interlock are separated in an unauthorized and violent way, the safety guard is opened and the enabling paths are switched off within 150 ms. This is signalled through the yellow and red LED blinking alternatively. To bring the system back in operational condition, the safety guard needs to be closed first and the solenoid control must be switched off and back on; the yellow and red LED now are blinking simultaneously. With the safety guard closed, an anti-tampering period of 10 minutes must be waited until the LEDs go out. Now, the system is back operational after the solenoid control has been switched off and back on. (The actuator nor the solenoid interlock are damaged!)

5.2 Description of the latching force adjustment

The latching force of the MZM 100 with ordering suffix -RE can be set in 8 steps of approx. 10 N each within a range of approx. 30 N to approx. 100 N. To this end, the MZM 100 TARGET is used directly on the fitted MZM 100.

Latching force adjustment for the MZM 100 with conventional diagnostic output

- 1.) Open the safety guard and isolate the MZM 100 from the voltage supply. Either switch off the voltage supply or pull out the connector.
- 2.) Put the adjustment target with the active side on the identification plate of the MZM 100.
- 3.) Switch the voltage supply of the MZM 100 back on and wait at least 10 seconds before removing the adjustment target. The component searches for the adjustment target. When the adjustment mode is active, the safety outputs remain disabled.
- 4.) Remove the adjustment target again from the component. The yellow LED of the MZM 100 will repeatedly flash briefly to show the currently set latching force level (e.g. 4 flashes = 4th latching force level approx. 60 N).
- 5.) Put the adjustment target approx. 1 second back on the solenoid interlock with the safety guard open to gradually increase the latching force by steps of approx. 10 N each. The number of flashes will increase accordingly.

The modified latching force can be checked directly on the safety guard. If necessary, the latching force can be increased by another step. When latching force level 8 is reached, level 1 will be activated when the target is placed back on the component.

- 6.) Switch off the voltage supply of the MZM 100 once more to permanently save the chosen latching force.

When the component is switched off, the adjustment mode is quit. After the voltage supply is switched back on, the MZM 100 is ready for operation.

Latching force indication

If the voltage supply of the MZM 100 is switched on when the safety guard is open, the yellow LED will show the set latching force for 10 seconds by means of repeated brief flashes (e.g. 4 flashes = 4th latching force level approx. 60 N). At stage 5, the last code is incomplete (5x flash with a complete or incomplete repeat of 3x flash).

Flash codes	Latching force RE	Latching force REM
1 flash pulse	approx. 30 N	approx. 45 N
2 flash pulses	approx. 40 N	approx. 55 N
3 flash pulses	approx. 50 N	approx. 65 N
4 flash pulses	approx. 60 N	approx. 75 N
5 flash pulses	approx. 70 N	approx. 85 N
6 flash pulses	approx. 80 N	approx. 95 N
7 flash pulses	approx. 90 N	approx. 105 N
8 flash pulses	approx. 100 N	approx. 115 N

Latching force adjustment for the MZM 100-...-SD with serial diagnostic function

The latching force can be adjusted through the latching force bits 1-3 of the request byte in 8 steps within a range of 30 ... 100 N (45 ... 115 N with permanent magnet).

Latching force bit			Latching force RE	Latching force REM
3	2	1		
0	0	0	approx. 30 N	approx. 45 N
0	0	1	approx. 40 N	approx. 55 N
0	1	0	approx. 50 N	approx. 65 N
0	1	1	approx. 60 N	approx. 75 N
1	0	0	approx. 70 N	approx. 85 N
1	0	1	approx. 80 N	approx. 95 N
1	1	0	approx. 90 N	approx. 105 N
1	1	1	approx. 100 N	approx. 115 N



The actual latching forces may deviate from the specified values owing to the different influences (e.g. angled position of actuator, contamination or damage to metal surface, etc.).



When the guard system is opened for the first time from the locked status, higher latching forces may be experienced on account of residual magnetism.

### 6. Diagnostic functions

#### 6.1 Diagnostic-LEDs

The MZM 100 signals the operational state as well as errors through three coloured LEDs installed on the front side of the device.

- green** Supply voltage on
- yellow** Switching condition
- red** Fault (refer to table 2: Flash codes of the red diagnostic LED)

#### 6.2 Solenoid interlock with conventional diagnostic output

The short-circuit proof diagnostic output OUT can be used for central visualisation or control tasks, e.g. in a PLC.

#### The diagnostic output is not a safety-relevant output!

Depending on the variant used, specific diagnostic signals are emitted (refer to table 1).

#### Error

Errors, which no longer guarantee the function of the MZM 100 solenoid interlock (internal error)s cause the safety outputs to be disabled within the risk time. Any error that does not immediately affect the safe functionality of the MZM 100 solenoid interlock (e.g. the ambient temperature too high, interference potential at a safety output, cross-wire short) will lead to a delayed shut-down (refer to table 2).

After the rectification of the error, the error message is reset by opening the corresponding safety guard.

#### Error warning

A fault has occurred, which causes the safety outputs to be disabled after 30 minutes. The safety outputs initially remain enabled. This enables the shutdown of the process in a controlled manner. An error warning is deleted when the cause of error is eliminated.



If more than one fault is detected at the safety outputs, the component will be electronically locked and a normal fault reset will no longer be possible.

To reset this type of interlocking, the component must be isolated from the power supply after elimination of the error causes.

### Behaviour of the diagnostic outputs of the W and W2 variants

#### Input signal magnet control



#### Normal sequence, door was locked

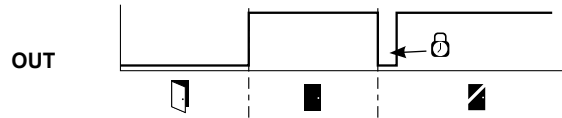

#### Door could not be locked or fault

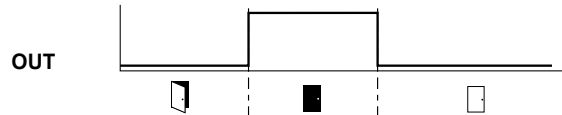

#### Key

- Lock
  - Unlock
  - Safety guard open
  - Safety guard closed
  - Safety guard not locked or fault
  - Safety guard locked
- Locking time: typically 100 ... 150 ms, max.: 1 s

### Evaluation of the diagnostic outputs of the W and W2 variants

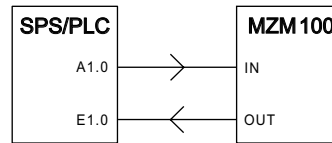

IN = 1 = locking

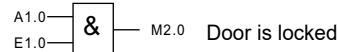

**Table 1: Diagnostic function**

The diagnostic output "OUT" signals faults before the safety outputs are disabled, thus enabling a controlled shutdown.

**Diagnostic function of MZM 100 variant "Solenoid interlock monitored"**

System condition	Solenoid control IN	LED			Safety outputs Y1, Y2	Diagnostic output OUT	
		green	red	yellow		-1P2P	-1P2PW
Guard open	0 V	On	Off	Off	0 V	0 V	0 V
Safety guard closed, actuator in	0 V	On	Off	Flashes	0 V	24 V	24 V
Safety guard closed and locked	24 V	On	Off	On	24 V	24 V	24 V
Solenoid interlock cannot be locked. Safety guard not correctly closed or magnet soiled	24 V	On	Off	Flashes	0 V	24 V	0 V
Error warning <sup>1)</sup> , Safety guard locked	24 V	On	Flashes <sup>2)</sup>	On	24 V	0 V	0 V
Error	0 V / 24 V	On	Flashes <sup>2)</sup>	Off	0 V	0 V	0 V
Violent separation of solenoid interlock and actuator <sup>3)</sup>	24 V	On	Flashes <sup>2)</sup>	Flashes <sup>2)</sup>	0 V	0 V	0 V

**Diagnostic function of MZM 100 B variant "Actuator monitored"**

System condition	Solenoid control IN	LED			Safety outputs Y1, Y2	Diagnostic output OUT
		green	red	yellow		-1P2PW2
Guard open	0 V	On	Off	Off	0 V	0 V
Safety guard closed, actuator in, safety guard can be locked	0 V	On	Off	Flashes	24 V	24 V
Safety guard closed and locked	24 V	On	Off	On	24 V	24 V
Solenoid interlock cannot be locked. Safety guard not correctly closed or magnet soiled	24 V	On	Off	Off	0 V	0 V
Error warning <sup>1)</sup> , actuator in	0 V / 24 V	On	Flashes <sup>2)</sup>	Flashes/ On	24 V	0 V
Error	0 V / 24 V	On	Flashes <sup>2)</sup>	Off	0 V	0 V

<sup>1)</sup> after 30 min -> fault

<sup>2)</sup> refer to flash code

<sup>3)</sup> cf. note in Section 5.1 on resetting the system to its operating state

**Table 2: flash codes of the red diagnostic LED**

Flash codes	Designation	Autonomous switch-off after	Error cause
1 flash pulse	Error (warning) at output Y1	30 min	Fault in output test or voltage at output Y1, although the output is disabled.
2 flash pulses	Error (warning) at output Y2	30 min	Fault in output test or voltage at output Y2, although the output is disabled.
3 flash pulses	Error (warning) cross-wire short	30 min	Cross-wire short between the output cables or fault at both outputs. After 30 minutes, voltage switch-off/on required
5 flash pulses	Actuator fault	0 min	Wrong or defective actuator.
6 flash pulses	Latching force fault	0 min	Latching force has dropped below 500 N (e.g. actuator misalignment)
10 flash pulses	Magnet temperature too high	0 min	The magnet is too hot: T > 70 °C
Continuous red signal	Internal error	0 min	Device defective

**6.3 Solenoid interlock with serial diagnostic function**

Solenoid interlocks with serial diagnostic function have a serial input and output instead of the conventional diagnostic output. If SD devices are wired in series, the safety channels as well as the inputs and outputs of the diagnostic channels are wired in series. The diagnostic data are transmitted through the series-wiring of the inputs and outputs.

Max. 31 safety switchgear with serial diagnostics can be wired in series. For the evaluation of the serial diagnostics line either the PROFIBUS-Gateway SD-I-DP-V0-2 or the Universal-Gateway SD-I-U-... are used. This SD-Gateway is integrated as a slave in an existing field bus system. In this way, the diagnostic signals can be evaluated by means of a PLC. The necessary software for the integration of the SD-Gateway is available for download at [products.schmersal.com](http://products.schmersal.com).

The response data and the diagnostic data are automatically and permanently written in an input byte of the PLC for each safety device in the series-wired chain. The request data for each safety device is transmitted to the component through an output byte of the PLC.

In case of a communication error between the SD-gateway and the safety device, the switching condition of the solenoid interlock is maintained.

**Error**

A fault has occurred, which causes the safety outputs to be disabled. The fault is reset, when the cause is eliminated and bit 7 of the request byte changes from 1 to 0 or the safety guard is opened. Faults at the safety outputs are only deleted upon the next release, as the fault rectification cannot be detected sooner.

**Error warning**

A fault has occurred, which causes the safety outputs to be disabled after 30 minutes. The safety outputs initially remain enabled. This enables the shutdown of the process in a controlled manner. An error warning is deleted when the cause of error is eliminated.

**Diagnostic error (warning)**

If an error (warning) is signalled in the response byte, detailed fault information can be read out.

**Table 3: I/O data and diagnostic data**

Communication directions: request byte: from the PLC to the local electronic safety switchgear response byte: from the local electronic safety switchgear to the PLC warning/error byte: from the local electronic safety switchgear to the PLC

The described condition is reached, when Bit = 1

Bit n°	Request byte	Response byte	Diagnostic Error warning	Diagnostic Error
Bit 0:	Magnet in, error reset	Safety output activated	Error output Y1	Error output Y1
Bit 1:	Latching force bit	Actuator detected	Error output Y2	Error output Y2
Bit 2:	Latching force bit	Solenoid interlock locked	Cross-wire short	Cross-wire short
Bit 3:	Latching force bit	---	Magnet temperature too high	Magnet temperature too high
Bit 4:	---	Input condition X1 and X2	Locking blocked or F < 500 N	Incorrect or defective actuator
Bit 5:	---	---	Internal device error	Internal device error
Bit 6:	---	Error warning	Communication error between the field bus Gateway and the safety switchgear	Violent separation of actuator and solenoid interlock (only in connection with "Solenoid interlock monitored")
Bit 7:	Error reset	Error (enabling path switched off)	Operating voltage too low	Operating voltage too low



**Table 4: Function of the visual diagnostic LED's, the serial status signals and the safety outputs by means of an example**

**- of MZM 100 variant "Solenoid interlock monitored"**

System condition	LED			Safety outputs Y1, Y2	Response byte bit n°:							
	green	red	yellow		7	6	5	4	3	2	1	0
Guard open	On	Off	Off	0 V	0	0	0	X	0	0	0	0
Safety guard closed, actuator in	On	Off	Flashes	0 V	0	0	0	X	0	0	1	0
Safety guard closed and locked	On	Off	On	24 V	0	0	0	X	0	1	1	1
Solenoid interlock cannot be locked. Safety guard not correctly closed or magnet soiled	On	Off	Flashes	0 V	0	0	0	X	0	0	1	0
Error warning <sup>1)</sup> Safety guard locked	On	Flashes <sup>2)</sup>	On	24 V	0	1	0	X	0	1	1	1
Error	On	Flashes <sup>2)</sup>	Off	0 V	1	0	0	X	0	X	X	0

**- of MZM 100 B variant "Actuator monitored"**

System condition	LED			Safety outputs Y1, Y2	Response byte bit n°:							
	green	red	yellow		7	6	5	4	3	2	1	0
Guard open	On	Off	Off	0 V	0	0	0	X	0	0	0	0
Safety guard closed, actuator in, safety guard can be locked	On	Off	Flashes	24 V	0	0	0	X	0	0	1	0
Safety guard closed and locked	On	Off	On	24 V	0	0	0	X	0	1	1	1
Solenoid interlock cannot be locked. Safety guard not correctly closed or magnet soiled	On	Off	Flashes	0 V	0	0	0	X	0	0	0	0
Error warning <sup>1)</sup> , actuator in	On	Flashes <sup>2)</sup>	On	24 V	0	1	0	X	0	X	1	1
Error	On	Flashes <sup>2)</sup>	Off	0 V	1	0	0	X	0	X	X	0

<sup>1)</sup> after 30 min -> fault  
<sup>2)</sup> refer to flash code

**7. Set-up and maintenance**

**7.1 Functional testing**

The safety function of the safety components must be tested. The following conditions must be previously checked and met:

1. Check max. axial misalignment of actuator and safety switchgear
2. Check max. angular misalignment (see "Mounting" part)
3. Check the integrity of the cable entry and connections.
4. Check the switch enclosure for damage.
5. Remove particles of dust and soiling.

**7.2 Maintenance**

In the case of correct installation and adequate use, the safety switchgear features maintenance-free functionality. A regular visual inspection and functional test, including the following steps, is recommended:

1. Check of the safety function
- Check the fixing of the safety switch and the actuator
- Check max. axial misalignment of actuator and solenoid interlock
- Check max. angular misalignment (see "Mounting" part)
- Check the integrity of the cable entry and connections.
- Check the switch enclosure for damages
- Remove soiling



Adequate measures must be taken to ensure protection against tampering either to prevent tampering of the safety guard, for instance by means of replacement actuators.

**Damaged or defective components must be replaced.**

**8. Disassembly and disposal**

**8.1 Disassembly**

The safety switchgear must be disassembled in a de-energised condition only.

**8.2 Disposal**

The safety switchgear must be disposed of in an appropriate manner in accordance with the national prescriptions and legislations.

9. Appendix

9.1 Wiring examples

The application examples shown are suggestions. They however do not release the user from carefully checking whether the switchgear and its set-up are suitable for the individual application.

**Wiring example 1: Series-wiring of the MZM 100 with conventional diagnostic output**

The voltage is supplied at both safety inputs of the terminal safety component of the chain (considered from the safety-monitoring module). The safety outputs of the first safety component are wired to the safety-monitoring module.

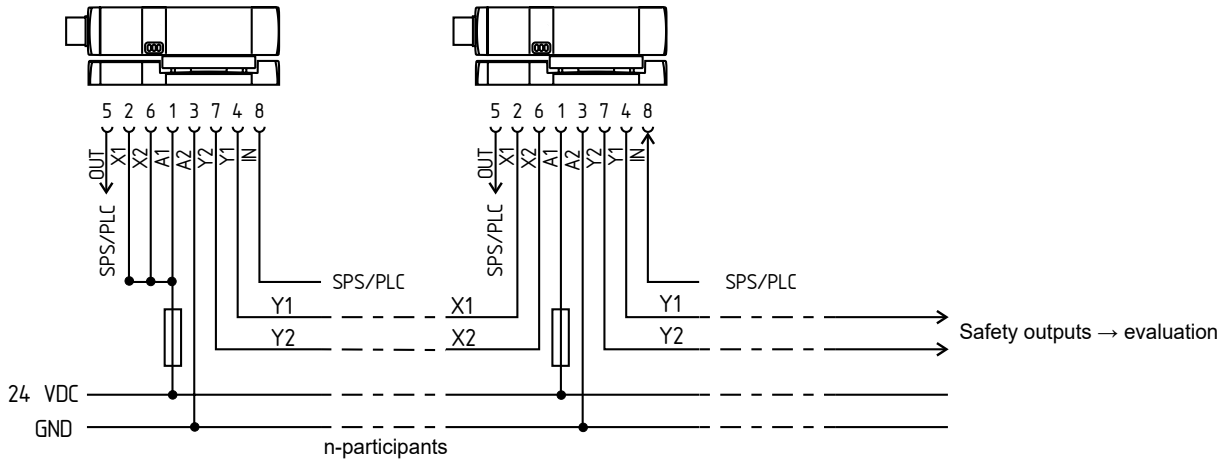

**Wiring example 2: series-wiring of the MZM 100 with serial diagnostic function**

The safety outputs of the first safety component are wired to the safety-monitoring module. The serial Diagnostic Gateway is connected to the serial diagnostic input of the first safety component.

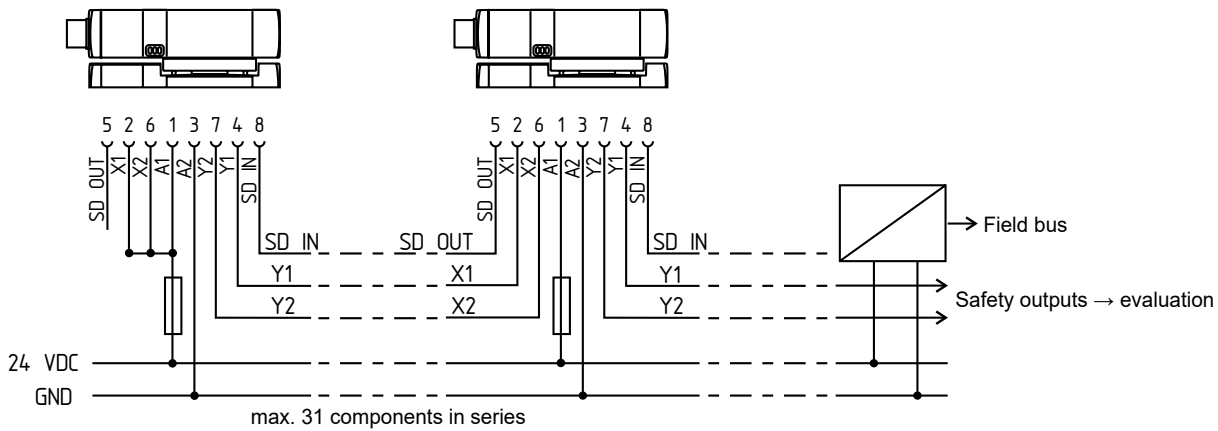

**9.2 Wiring configuration and connector accessories**

Function safety switchgear		Pin configuration of the connector	Conductor numbering or colour code of the Schmersal connectors		Poss. colour codes of other customary connectors to EN 60947-5-2	
			M23, IP67	M12, IP67 / IP69 to DIN 47100		
A1	with conventional diagnostic output	U <sub>e</sub>	1	1	WH	BN
X1		Safety input 1	2	2	BN	WH
A2		GND	3	3	GN	BU
Y1		Safety output 1	4	4	YE	BK
OUT	Diagnostic output	SD output	5	5	GY	GY
X2		Safety input 2	6	6	PK	PK
Y2		Safety output 2	7	7	BU	VT
IN	Solenoid control	SD input	8	8	RD	OR
		without function	9			

**Connector plug ST M23, (8+1)-pole**



**Connector plug ST2 M12, 8-pole**



Connecting cables with female connector  
IP67, M23, (8+1)-pole - 8 x 0.75 mm<sup>2</sup>

Cable length	Part number
5.0 m	101209959
10.0 m	101209958

Connecting cables with coupling (female)  
IP67 / IP69, M12, 8-pole - 8 x 0.25 mm<sup>2</sup>  
to DIN 47100

Cable length	Part number
2.5 m	103011415
5.0 m	103007358
10.0 m	103007359

Connector with plug (female)  
IP67, M23, (8+1)-pole - 8 x 0.75 mm<sup>2</sup>

Versions	Part number
with soldering terminals	101209970
with crimp terminals	101209994

10. EU Declaration of conformity

EU Declaration of conformity



Original  
K.A. Schmersal GmbH & Co. KG  
Möddinghofe 30  
42279 Wuppertal  
Germany  
Internet: www.schmersal.com

We hereby certify that the hereafter described components both in their basic design and construction conform to the applicable European Directives.

**Name of the component:** MZM 100,  
MZM 100 B

**Type:** See ordering code

**Description of the component:** Interlocking device with electromagnetic interlock for safety functions (MZM 100) and safety switch with interlocking functions (MZM 100 B)

**Relevant Directives:** Machinery Directive 2006/42/EC  
EMC-Directive 2014/30/EU  
RoHS-Directive 2011/65/EU

**Applied standards:** EN 60947-5-3:2013  
EN ISO 14119:2013  
EN ISO 13849-1:2015  
IEC 61508 parts 1-7:2010

**Notified body for the prototype test:** TÜV Rheinland Industrie Service GmbH  
Am Grauen Stein, 51105 Köln  
ID n°: 0035

**EC-prototype test certificate:** 01/205/5778.00/20

**Person authorised for the compilation of the technical documentation:** Oliver Wacker  
Möddinghofe 30  
42279 Wuppertal

**Place and date of issue:** Wuppertal, November 18, 2020

MZM100-H-DE

Authorised signature  
**Philip Schmersal**  
Managing Director



The currently valid declaration of conformity can be downloaded from the internet at [products.schmersal.com](http://products.schmersal.com).

