



EN Operating Instructions pages 1 to 6
Original

Content

1 About this document

1.1 Function 1

1.2 Target group: authorised qualified personnel. 1

1.3 Explanation of the symbols used 1

1.4 Appropriate use 1

1.5 General safety instructions 1

1.6 Warning about misuse 1

1.7 Exclusion of liability 2

2 Product description

2.1 Ordering code 2

2.2 Special versions. 2

2.3 Purpose 2

2.4 Actuating features 2

2.5 Technical Data 2

2.6 Safety classification 3

3 Assembly

3.1 Dimensions 3

4 Electrical connection

4.1 General information for electrical connection. 4

4.2 Strand lengths 4

4.3 Design of electrical connection 4

4.4 Wiring of NO contacts with SRB-E-201ST and SRB-E-201LC 5

4.5 Wiring of NO contacts with SRB-E-301ST. 5

5 Set-up and maintenance

5.1 Functional testing. 5

5.2 Maintenance 5

6 Disassembly and disposal

6.1 Disassembly. 5

6.2 Disposal 5

7 EU Declaration of conformity

1. About this document

1.1 Function

This operating instructions manual provides all the information you need for the mounting, set-up and commissioning to ensure the safe operation and disassembly of the safety switchgear. The operating instructions must be available in a legible condition and a complete version in the vicinity of the device.

1.2 Target group: authorised qualified personnel

All operations described in this operating instructions manual must be carried out by trained specialist personnel, authorised by the plant operator only.

Please make sure that you have read and understood these operating instructions and that you know all applicable legislations regarding occupational safety and accident prevention prior to installation and putting the component into operation.

The machine builder must carefully select the harmonised standards to be complied with as well as other technical specifications for the selection, mounting and integration of the components.

1.3 Explanation of the symbols used



Information, hint, note:

This symbol indicates useful additional information.



Caution: Failure to comply with this warning notice could lead to failures or malfunctions.

Warning: Failure to comply with this warning notice could lead to physical injury and/or damage to the machine.

1.4 Appropriate use

Products in Schmersal's range are not intended to be used by private end consumers.

The products described in these operating instructions are developed to execute safety-related functions as part of an entire plant or machine. It is the responsibility of the manufacturer of a machine or plant to ensure the correct functionality of the entire machine or plant.

The safety switchgear must be exclusively used in accordance with the versions listed below or for the applications authorised by the manufacturer. Detailed information regarding the range of applications can be found in the chapter "Product description".

1.5 General safety instructions

The user must observe the safety instructions in this operating instructions manual, the country specific installation standards as well as all prevailing safety regulations and accident prevention rules.



Further technical information can be found in the Schmersal catalogues or in the online catalogue on the Internet: products.schmersal.com.

The information contained in this operating instructions manual is provided without liability and is subject to technical modifications.

There are no residual risks, provided that the safety instructions as well as the instructions regarding mounting, commissioning, operation and maintenance are observed.

1.6 Warning about misuse



In case of improper use or manipulation of the safety switchgear, personal hazards or damages to machinery or plant components cannot be excluded.

1.7 Exclusion of liability

We shall accept no liability for damages and malfunctions resulting from defective mounting or failure to comply with this operating instructions manual. The manufacturer shall accept no liability for damages resulting from the use of unauthorised spare parts or accessories.

For safety reasons, invasive work on the device as well as arbitrary repairs, conversions and modifications to the device are strictly forbidden, the manufacturer shall accept no liability for damages resulting from such invasive work, arbitrary repairs, conversions and/or modifications to the device.

2. Product description

2.1 Ordering code

This operating instructions manual applies to the following types:

ZSD^{①-②}

No.	Option	Description
①	5CC 6CC	2 NO contacts, 1 auxiliary contact (NC) 2 NO contacts, 1 auxiliary contact (NC) with additional pushbutton (NO) in the device head
②	5 m	Connecting cable, 5 m

Not all component variants, which are possible according to this order code, are available.



Only if the information described in this operating instructions manual are realised correctly, the safety function and therefore the compliance with the Machinery Directive is maintained.



On devices with pre-wired cable, checks must be made to determine whether or not the cable is suitable for the application (e.g. mechanical suitability, thermal requirements, etc.).

2.2 Special versions

For special versions, which are not listed in the ordering code below 2.1, these specifications apply accordingly, provided that they correspond to the standard version.

2.3 Purpose

The electromechanical enabling switches of the ZSD series are for instance used on industrial robots and automated production systems to activate the control functions for hazardous situations through other control devices.

An enabling device is an additional manually-operated control device, which is used in conjunction with the start equipment and enables a machine function, when it is continuously actuated.

The redundant contact configuration enables signal evaluation with common safety relay modules with cross-fault monitoring. The contact configuration in accordance with product standard EN IEC 60947-5-8 or test principle GS-ET-22 enables signal processing according to Category 3 PL d.

2.4 Actuating features

	Connector no.		
Push (Level 1 → 2 → 3) →	1-2		⊖
	5-6		
	3-4		
Release (Level 2 → 1) ←	1-2		
	5-6		
	3-4		
Release (Level 3 → 1) ←	1-2		
	5-6		
	3-4		

Key:

- Contact open
- Contact closed
- ⊖ Positive break



The entire concept of the control system, in which the safety component is integrated, must be validated to the relevant standards.

2.5 Technical Data

Standards:	EN 60947-5-1, EN IEC 60947-5-8, EN ISO 13849-1
Ambient temperature:	-10 °C ... +60 °C (without condensation)
Storage temperature:	-40 °C ... +80 °C (without condensation)
Relative humidity:	45 ... 85% (no condensation)
Degree of pollution:	3
Rated impulse withstand voltage:	
- without additional pushbutton:	2.5 kV;
- with additional pushbutton:	1.5 kV
Switching frequency:	1,200 / h
Mechanical life:	
- of the NO contact's switch insert:	level 1-2-1: min. 10 ⁶ operations level 1-2-3-1: min. 10 ⁵ operations
Electrical life:	
- of the NO contact's switch insert:	10 ⁵ operations (at full load)
Positive break travel:	4.7 mm
Minimum required force for positive break:	70 N
Resistance to shocks:	operation: 150 m/s ² , Destructive: 1,000 m/s ²
Resistance to vibrations:	operation: 5 ... 55 Hz, amplitude 0.5 mm min. destructive: 16.7 Hz, amplitude 1.5 mm min.
Connection:	cage clamps
Cable section:	0.2 ... 1.5 mm ²
Cable diameter:	7 ... 13 mm
Cable gland	M20
Tensile strength of the connection:	min. 20 N
Recommended Tightening torque for the screws:	
- Enclosure screws:	1.2 ± 0.1 Nm
- Cable entry:	4.0 ± 0.3 Nm
- Rubber cap screws:	—*
- Board screws:	—*
* Do NOT remove!	
Degree of protection:	
- ZSD5CC:	IP66
- ZSD6CC:	IP65
Max. fuse rating:	50 A (250 V)
Protection of the contacts:	external (I _k = 1000 A) to EN 60947-5-1, safety fuse 10 A quick blow
Recommended short-circuit fuse:	250 V / 10 A quick-blow
Weight:	ZSD5CC: approx. 195 g ZSD6CC: approx. 205 g
Electrical specification of the ZSD5CC/ZSD6CC base device:	
Rated operating voltage U _e :	250 VAC/DC
Rated operating current I _e :	2.5 A

NO contacts (2 NO contact):

Ohmic load (AC-12):	125 V: 1.0 A; 250 V: 0.5 A
Inductive load (AC-15):	125 V: 0.7 A; 250 V: 0.5 A
Ohmic load (DC-12):	30 V: 1.0 A; 125 V: 0.2 A
Inductive load (DC-13):	30 V: 0.7 A; 125 V: 0.1 A

Auxiliary contact (1 NC contact):

Ohmic load (AC-12):	125 V: 2.5 A; 250 V: 1.5 A
Inductive load (AC-15):	125 V: 1.5 A; 250 V: 0.75 A
Ohmic load (DC-12):	30 V: 2.5 A; 125 V: 1.1 A; 250 V: 0.55 A
Inductive load (DC-13):	30 V: 2.3 A; 125 V: 0.55 A; 250 V: 0.27 A

Additional pushbutton for ZSD6CC:

Ohmic load (AC-12):	125 V: 0.5 A
Inductive load (AC-15):	125 V: 0.3 A
Ohmic load (DC-12):	30 V: 1.0 A; 125 V: 0.2 A
Inductive load (DC-13):	30 V: 0.7 A; 125 V: 0.1 A

Ratings approved by safety agencies

(1) TÜV Rating

Three-position enabling switch AC-15 250V/0.5A DC-13 125V/0.1A
DC-13 30V/0.7A

Monitor switch AC-15 250V/0.75A DC-13 125V/0.22A

DC-13 30V/2.3A

Emergency stop pushbutton switch AC-15 250V/1.5A DC-13 30V/1A

(2) UL, c-UL Rating

Three-position enabling switch AC 250V/0.5A Pilot Duty

DC 125V/0.1A Pilot Duty

DC 30V/0.7A Pilot Duty

Monitor switch AC 250V/0.75A Pilot Duty

Emergency stop pushbutton switch AC 250V/1.5A Pilot Duty

DC 30V/1A Pilot Duty

- Ambient Temperature +40°C

- Environmental Rating Type 4X, Indoor Use Only.

- This device has only been investigated for shock and fire to UL508.

(3) CCC Rating

Three-position enabling switch AC-15 250V/0.5A DC-13 30V/0.7A

Monitor switch AC-15 250V/0.75A DC-13 30V/2.3A

Emergency stop pushbutton switch AC-15 250V/0.5A DC-13 250V/0.1A

Momentary pushbutton switch AC-12 125V/0.5A DC-12 30V/1.0A

2.6 Safety classification

Standards: EN ISO 13849-1, IEC 61508

PL: d

Category: 3

B_{10D} value (for one channel): 100,000

$$MTTF_D = \frac{B_{10D}}{0,1 \times n_{op}} \quad n_{op} = \frac{d_{op} \times h_{op} \times 3600 \text{ s/h}}{t_{cycle}}$$

n_{op} = average number of activations per year

d_{op} = average number of operating days per year

h_{op} = average number of operating hours per day

t_{cycle} = average demand rate of the safety function in s
(e.g. 4 × per hour = 1 × per 15 min. = 900 s)

(Determined values can vary depending on the application-specific parameters hop, dop and tcycle as well as the load.)

Actuating features

The redundant contact configuration enables signal evaluation with common safety relay modules with cross-fault monitoring.

The contact configuration in accordance with product standard

EN IEC 60947-5-8 or test principle GS-ET-22 enables signal processing according to Category 3 PL d.



The monitoring device must be equipped with a cross-wire short monitoring.

3. Assembly

3.1 Dimensions

Dimensions of the ZSD enabling switch

ZSD5CC

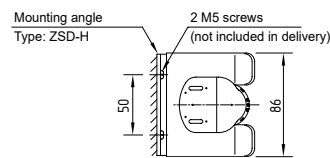

ZSD6CC

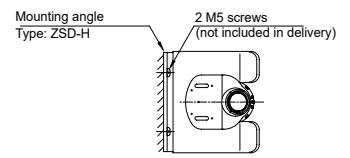

Pushbuttons

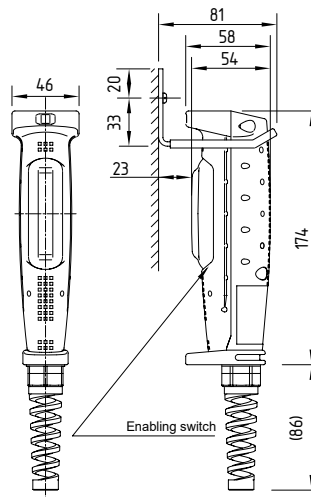
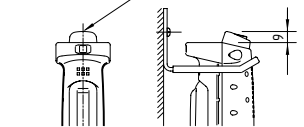

Mounting angle ZSD-H (not included in delivery)

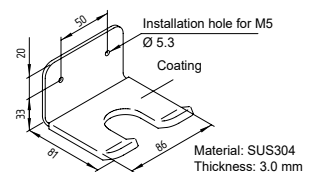

4. Electrical connection

4.1 General information for electrical connection



The electrical connection may only be carried out by authorised personnel in a de-energised condition.



If the device is used in humid or damp rooms, a suitable connecting cable must be used.

4.2 Strand lengths

Connection ① ... ④: $L1 = 35 \text{ mm} + x = 8 \dots 9 \text{ mm}$

Connection ⑤ ... ⑧: $L2 = 30 \text{ mm} + x = 8 \dots 9 \text{ mm}$

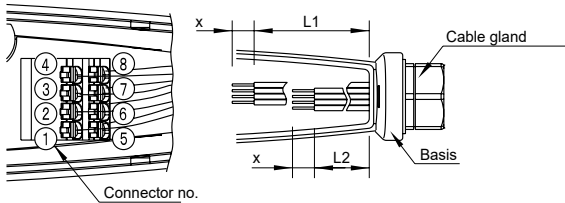

Strand section $0.2 \dots 1.5 \text{ mm}^2$ (1 strand per connection)

Settle length x of the conductor: $8 \dots 9 \text{ mm}$



4.3 Design of electrical connection

Insertion of the cable:

- Guide the cable into the cable connection. When using with flex, insert the wire while pressing the trigger with a slotted screwdriver.

Removing the cable:

- Press the trigger with a slotted screwdriver and pull the cable straight out.

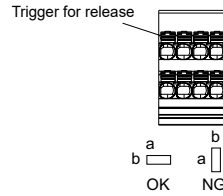

When using braids, it is important to ensure that there is no short circuiting of adjacent terminals due to protruding wires. Do not solder wires so as to avoid protrusions. Use only copper wire with $60\text{-}75^\circ\text{C}$ (UL508). Cabling must be installed in accordance with GS-ET-22.



- Pull on the cable slightly to ensure that it is properly connected.
- After wiring, the contact elements must be cleaned (i.e. remove excess cables etc.).
- The voltage source must be interrupted when the cable is released.
- Press the trigger with a force of 20 N, not with a force of 40 N or more.
- Do not pull the wire out without pressing the trigger. When pulling the cable out, always pull straight, otherwise the bushing may be damaged.
- Carefully cut the wire to ensure that the end is flat.
- Ensure that the wire-end ferrule is filled fully with the wire. Depending on the diameter, the wire should protrude 0 to 1 mm from the wire-end ferrule. Observe the instructions of the wire-end ferrule manufacturer.

Dimensions of the cable entry

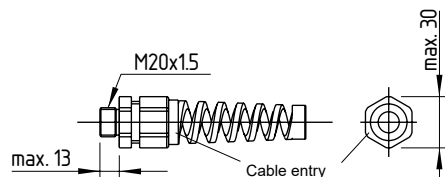

- Degree of protection:** Use a cable entry with degree of protection IP66 or above.
- Cable entry used:** Type: SKINTOP-BS-M20x1.5-B (Manufacturer: LAPP, Germany)
- Cable diameter to be used:** Outer diameter $7 \dots 13 \text{ mm}$

4.4 Wiring of NO contacts with SRB-E-201ST and SRB-E-201LC

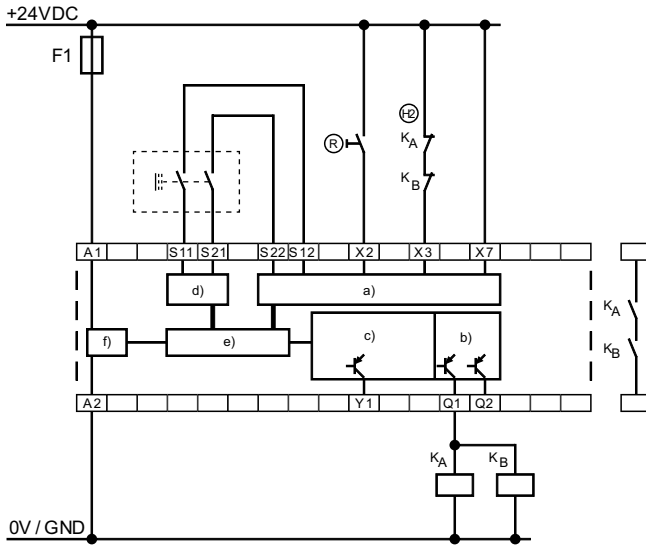

Clip	Description
1	NO contact 1-2
2	
3	NO contact 3-4
4	
5	Auxiliary contact 5-6
6	
7	Pushbuttons 7-8 (only for ZSD6CC)
8	

4.5 Wiring of NO contacts with SRB-E-301ST

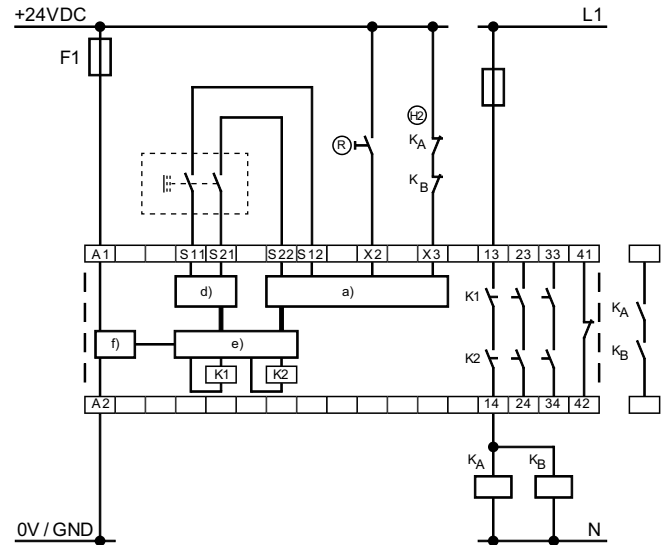

Key

- a) Safety inputs
- b) Safety outputs
- c) Signalling outputs
- d) Clock outputs
- e) Processing
- f) Power

5. Set-up and maintenance

5.1 Functional testing

The safety function of the enabling switch must be tested. The following conditions must be checked and met:

- Check the integrity of the cable entry and connections
- Check the enabling switch for damages.

5.2 Maintenance

A regular visual inspection and functional test, including the following steps, is recommended:

- Check the correct fixing of the enabling switch and the contact elements.
- Remove particles of dust and soiling.
- Check cable entry and connections.

Damaged or defective components must be replaced.

6. Disassembly and disposal

6.1 Disassembly

The safety switchgear must be disassembled in a de-energised condition only.

6.2 Disposal

The safety switchgear must be disposed of in an appropriate manner in accordance with the national prescriptions and legislations.

7. EU Declaration of conformity

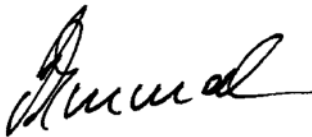
EU Declaration of conformity		
Original	K.A. Schmersal GmbH & Co. KG Möddinghofe 30 42279 Wuppertal Germany Internet: www.schmersal.com	
We hereby certify that the hereafter described components both in their basic design and construction conform to the applicable European Directives.		
Name of the component:	ZSD5CC / ZSD6CC	
Type:	See ordering code	
Description of the component:	Enabling switches	
Relevant Directives:	2006/42/EC Machinery Directive 2011/65/EU RoHS-Directive	
Applied standards:	EN 60947-5-1:2017 + AC:2020 EN IEC 60947-5-8:2021 EN ISO 13849-1:2015	
Person authorised for the compilation of the technical documentation:	Oliver Wacker Möddinghofe 30 42279 Wuppertal	
Place and date of issue:	Wuppertal, July 23, 2023	
ZSD5_6CC-B-EN		
	Authorised signature Philip Schmersal Managing Director	



The currently valid declaration of conformity can be downloaded from the internet at products.schmersal.com.

