

BI10U-M30-AD4X-H1144

Inductive Sensor

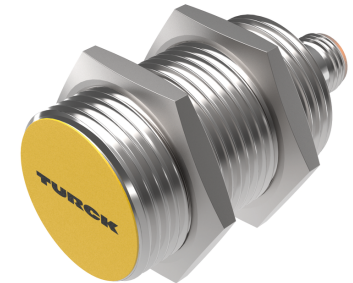
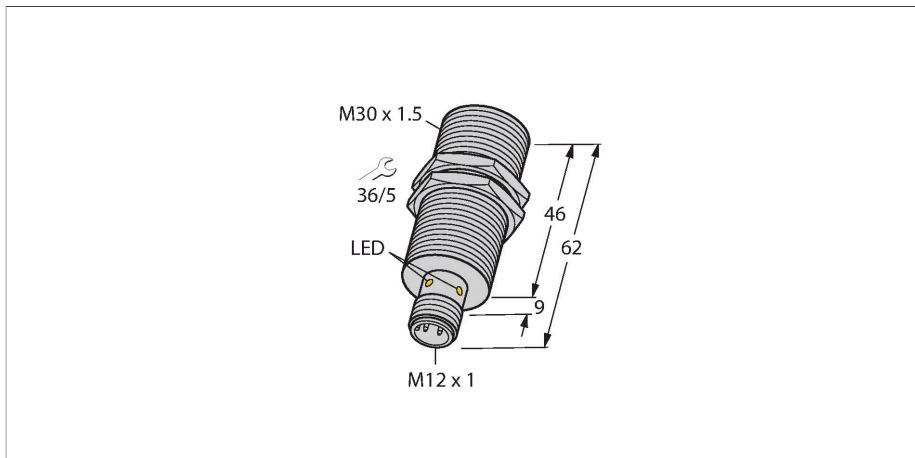

Technical data

Type	BI10U-M30-AD4X-H1144
ID	4405072
General data	
Rated switching distance	10 mm
Mounting conditions	Flush
Secured operating distance	$\leq (0.81 \times S_n)$ mm
Repeat accuracy	$\leq 2\%$ of full scale
Temperature drift	$\leq \pm 10\%$
	$\leq \pm 15\%$, $\leq -25\text{ °C}$ v $\geq +70\text{ °C}$
Hysteresis	3...20 %
Electrical data	
Operating voltage	10...65 VDC
Residual ripple	$\leq 10\% U_{ss}$
DC rated operational current	$\leq 100\text{ mA}$
Residual current	$\leq 0.8\text{ mA}$
Isolation test voltage	$\leq 0.5\text{ kV}$
Short-circuit protection	yes / Cyclic
Voltage drop at I_o	$\leq 5\text{ V}$
Wire breakage/Reverse polarity protection	Complete
Output function	2-wire, NO contact, 2-wire
DC field stability	300 mT
AC field stability	300 mT _{ss}
Smallest operating current	$\geq 3\text{ mA}$
Switching frequency	0.01 kHz
Mechanical data	
Design	Threaded barrel, M30 x 1.5

Features

- M30 × 1.5 threaded tube
- Chrome-plated brass
- Factor 1 for all metals
- Resistant to magnetic fields
- DC 2-wire, 10...65 VDC
- NO contact
- M12 x 1 male connector

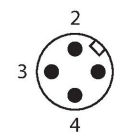
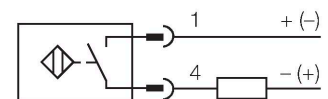

Functional principle

Inductive sensors are designed for wear-free and contactless detection of metal objects. Inprox+ sensors have significant advantages due to their patented multi-coil system. They excel thanks to their optimum switching distances, maximum flexibility and operational reliability as well as efficient standardization.

Technical data

Dimensions	62 mm
Housing material	Metal, CuZn, Chrome-plated
Active area material	Plastic, LCP
Max. tightening torque of housing nut	75 Nm
Electrical connection	Connector, M12 × 1
Environmental conditions	
Ambient temperature	-25...+70 °C
Vibration resistance	55 Hz (1 mm)
Shock resistance	30 g (11 ms)
Protection class	IP68
MTTF	874 years acc. to SN 29500 (Ed. 99) 40 °C
Switching state	LED, Yellow

Mounting instructions

Mounting instructions/Description

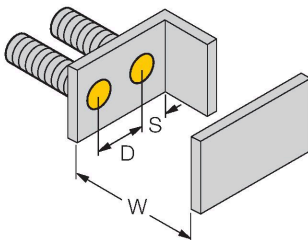
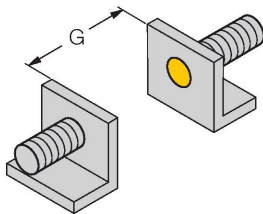
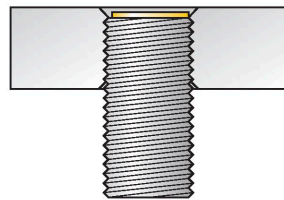
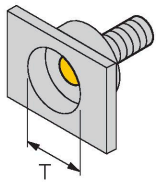

Distance D	60 mm
Distance W	3 x Sn
Distance T	3 x B
Distance S	1.5 x B
Distance G	6 x Sn
Diameter active area B	Ø 30 mm

All flush mountable aprox+ threaded barrel types are also recessed mountable. Safe operation is ensured if the sensor is screwed in by half a turn.

Accessories

BST-30B

6947216

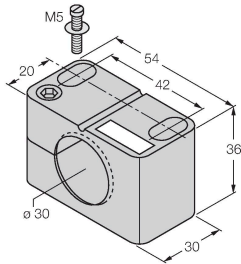

Mounting clamp for threaded barrel sensors, with dead-stop; material: PA6

QM-30

6945103

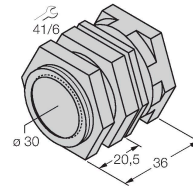

Quick-mount bracket with dead-stop; material: Chrome-plated brass. Male thread M36 × 1.5. Note: The switching distance of the proximity switches may change when using quick-mount brackets.

MW-30

6945005

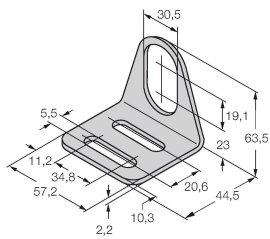

Mounting bracket for threaded barrel sensors; material: Stainless steel A2 1.4301 (AISI 304)

BSS-30

6901319



Mounting clamp for smooth and threaded barrel sensors; material: Polypropylene

BL20-4DI-NAMUR

6827212

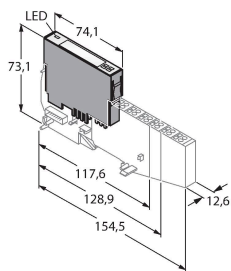

4 digital inputs acc. to EN 60947-5-6 For NAMUR sensors, de-energized contacts or uprox@+ 2-wire DC sensors.