

# WKC4.4T-P7X2-2-RSC4.4T/TXY

## Actuator and Sensor Cable, PUR – Extension Cable

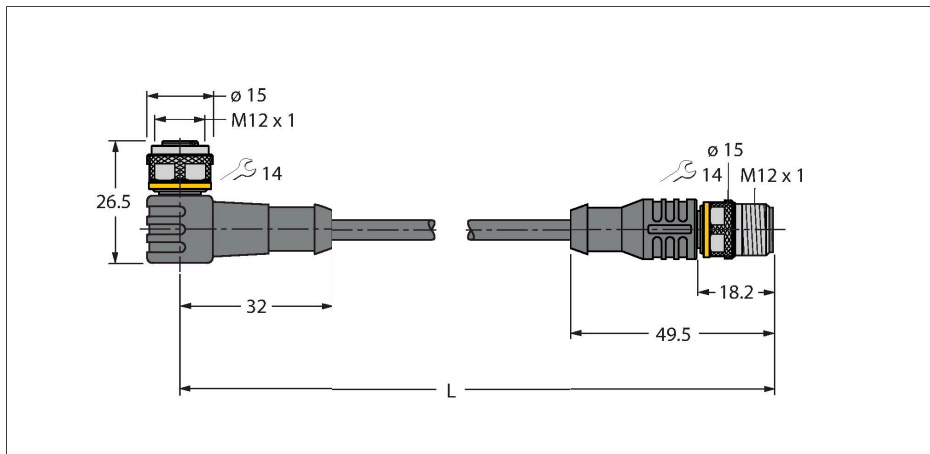

### Features



- Female M12, angled, 4-pin
- With 2-color LED (PNP, yellow, green)
- Male M12, straight, 4-pin
- Jacket material: PUR
- Jacket color: yellow
- Suitable for drag chain use
- Resistant to chemicals, UV radiation and oils
- Flame retardant (FT2 acc. to UL 1581, IEC 60332-2-2)
- Resistant to welding sparks
- Free from halogen, silicone, PVC and LABS
- Particularly resistant to abrasion
- Protection class: IP67, IP69K
- Cable length: 2.0 m

### Technical data

Type	WKC4.4T-P7X2-2-RSC4.4T/TXY
ID	6631712
Connector A	Female, M12 × 1, Angled, A-coded
Number of Pins	4
Contacts	Brass, CuZn, Gold-plated
Contact carriers	Plastic, TPU, Black
Connector body	Plastic, TPU, Translucent
Coupling nut/screw	Brass, CuZn, Nickel-plated
Seal	Plastic, FPM/FKM
LED display	dual LED
Display operating voltage	LED, Green
Display switch state	LED, Yellow
Mechanical lifespan	> 100 Mating cycles
Pollution degree	3
Protection class	IP67, IP69K, Only in screwed condition
Connector B	Male, M12 × 1, Straight, A-coded
Number of pins	4
Contacts	Brass, CuZn, Gold-plated
Contact carriers	Plastic, TPU, Black
Connector body	Plastic, TPU, Black
Coupling nut/retaining screw	Brass, CuZn, Nickel-plated
Mechanical life	> 100 Mating cycles
Pollution degree	3
Protection class	IP67, IP69K, Only when screwed together
Cable	
Cable diameter	Ø 4.5 mm ±0.20
Cable length	2 m

### Cable Cross-Section

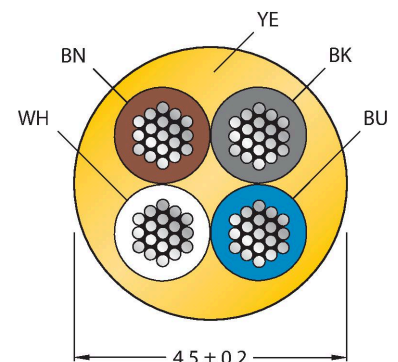

### Contact assignment



### Circuit Diagram

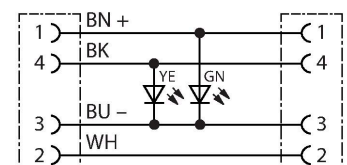

## Technical data

Cable jacket	PUR, Yellow
Core insulation	PP
Core cross-section	4 x 0.34 mm <sup>2</sup>
Arrangement of strands	42 x 0.1 mm
Core colors	BN, WH, BU, BK
<b>Electrical properties at +20 °C</b>	
Rated voltage	30 V <sub>DC</sub>
Test voltage	2000 V
Current	4 A
Insulation resistance	> 30.5 MΩ/km
forward resistance	max. 57 Ω/km
<b>Mechanical and chemical properties</b>	
Bending radius (stationary installation)	≥ 5 x Ø
Bending radius (flexible use)	≥ 10 x Ø
Bending cycles	≥ 5 million
Admissible acceleration	max. 5 m/s <sup>2</sup>
Admissible travel path, horizontal	5 m (at 5 m/s <sup>2</sup> )
Admissible travel path, vertical	2 m (at 5 m/s <sup>2</sup> )
Admissible traversing speed	3.3 m/s
Torsional stress	± 180 °/m
Ambient temperature range (stationary)	-50...+80 °C
Ambient temperature range (In motion)	-25...+80 °C
Ambient temperature during drag chain operation	-25...+60 °C
Approvals	cULus

## Accessories

<b>TORQUE-WRENCH-SET-AS</b>	6936170	<b>BLANK-LABEL-FOR-CORDSETS-TEL-TXL</b>	6936206
Torque wrench set; handles with adjustable torque 0.4-1.0 Nm, torque wrench for M8 (SW9), fork wrench for M12 (SW 14)		Label for TEL and TXL cables, length: 18 mm, height: 4 mm, material: polycarbonate (PC), color: white, halogen-free and flame-retardant	

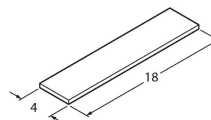

## Accessories

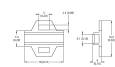
Dimension drawing	Type	ID	
	LABEL-HOLDER-FLEX-PVC	100048170	PVC label holder for identification of extension cables (TEL/TXL product series); for cable diameters: min. 5 mm;

Dimension drawing	Type	ID
		dimensions 4 × 18 mm; delivery unit: 50 pcs. per package