

WLS28-2XW285XPBQ

Work Light – Linear Light

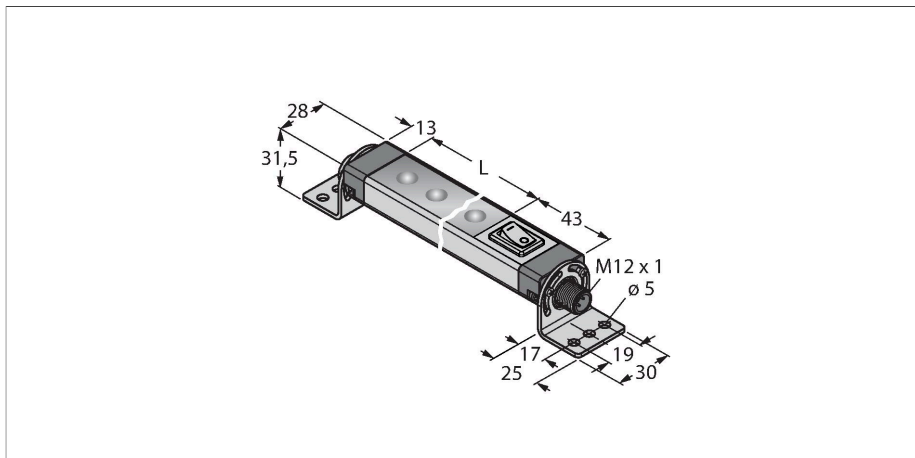

Technical data

Type	WLS28-2XW285XPBQ
ID	3087995
Signal and display data	
Purpose	LED work light
Function	Linear light
Light type	White
Color temperature	6100...+7000 K
Luminous flux lumen	650 lm
Aperture angle degree	60 °
Beam angle	wide beam 40-80°
LED service life (L70)	50000 h
Dimmable	Two-stage
Features of color 1	White, Permanently on, 800 lm
Electrical data	
Operating voltage	12...30 VDC
DC rated operational current	≤ 660 mA
Input power	7.92 W
Mechanical data	
Cascadable	No
Design	Rectangular, WLS28-2
Dimensions	357 x 28 x 25 mm
Housing material	Metal, AL
Window material	Polycarbonate, clear
Electrical connection	Connector, M12 × 1, PVC
Number of cores	4
Ambient temperature	-40...+70 °C
Storage temperature	-40...+70 °C

Features

- ON/OFF switch
- Light beam: 285mm
- Operating voltage: 12...30 VDC
- Protection class: IP50
- Color: White
- M12 x 1 male, straight, 4-pin
- SMBWLS28RA mounting bracket included in delivery

Wiring diagram

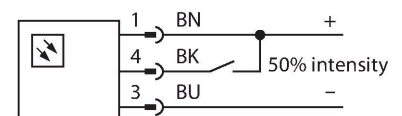

Functional principle

The low-energy LED work lights are ideally suited for industrial applications. The color temperature is between 6,000 and 7,100 Kelvin (cool white). Depending on the model, the luminous flux is 325 or 2600 lumen. Some work lights are switched on/off via supply power (10...30 VDC) and some types by means of a button directly at the LED lamp. In addition, the LED can be dimmed to 50% of its light output by activating a high signal on PIN 4, or for the variants with a switch, by means of a further switch position. On some models the light output is continuously dimmable via a PWM signal on pin 4. Cascadable variants are also available. Variants with a clear or diffuse plastic windows, as well as with an aperture angle of 25°.

Application note:

Cascading with 12 V supply allows total light length of 1.4 m. Cascading with 24 V supply allows total light length of 3.0 m. Cascading with 30 V supply allows total light length of 3.1 m.

Technical data

Relative humidity	0...90 %
Protection class	IP50
Tests/approvals	
Approvals	CE, UL

At 50% light intensity, the length specifications should be doubled.

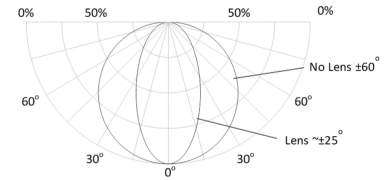

Light Length	Typical Current			Max. Current
	12 VDC	24 VDC	30 VDC	A
145 mm	0.33 A	0.15 A	0.12 A	0.4
285 mm	0.66 A	0.30 A	0.24 A	0.8
430 mm	1.01 A	0.46 A	0.36 A	1.2
570 mm	1.36 A	0.61 A	0.48 A	1.6
710 mm	1.75 A	0.77 A	0.60 A	2.0
850 mm	2.13 A	0.92 A	0.73 A	2.4
990 mm	2.59 A	1.08 A	0.85 A	2.8
1130 mm	3.04 A	1.24 A	0.97 A	3.2

Accessories

SMBWLSMAG 3019574
Magnetic fixture for mounting work lights and sensors, 2 pieces

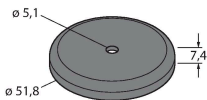

SMBWLS28RA 3015764
Mounting bracket, angled, metal, for WLS28 work lights, 5 mm drill holes, screw set included

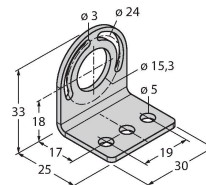

SMBWLS28SP 3088063
Snap bracket for mounting WLS28 work lights

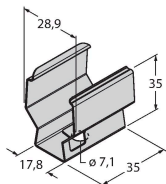

Accessories

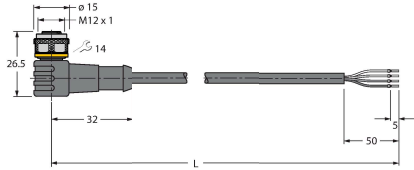
Dimension drawing	Type	ID	
	RKC4.4T-2/TEL	6625013	Connection cable, M12 female connector, straight, 4-pin, cable length: 2 m, jacket material: PVC, black; cULus approval
	WKC4.4T-2/TEL	6625025	Connection cable, M12 female connector, angled, 4-pin, cable length: 2 m, jacket material: PVC, black; cULus approval