

RSSD-4422-20M

Industrial Ethernet Cable – Connection Cable

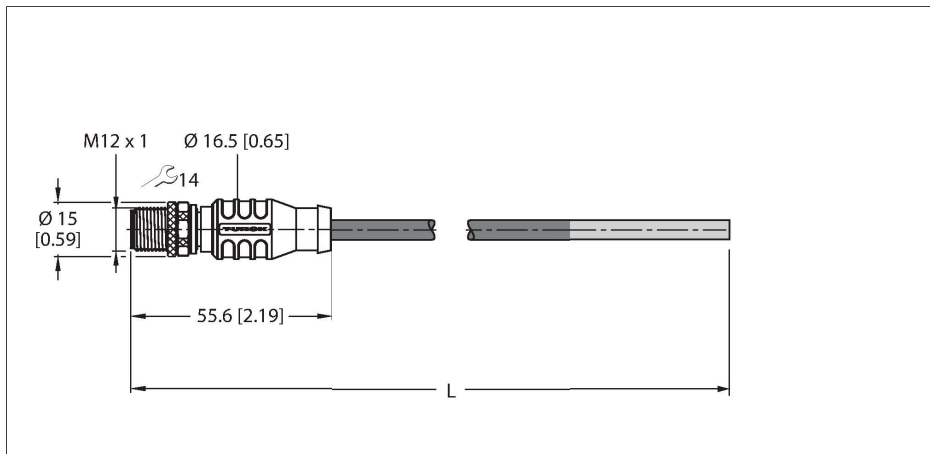

Technical data

Type	RSSD-4422-20M
ID	6635583
Connector A	Male, M12 × 1, Straight, D-coded
Number of Pins	4
Contacts	Metal, CuZn, Gold-plated
Contact carriers	Plastic, TPU, Black
Connector body	Plastic, TPU, Black
Coupling nut/screw	Brass, CuZn, Nickel-plated
Tightening torque (range)	0.8 ... 1 Nm (observe max. torque of mating connector!)
Mechanical lifespan	> 100 Mating cycles
Pollution degree	3
Protection class	IP67, Only in screwed condition
Cable	
Network protocol	Ethernet
Cable diameter	Ø 6.5 mm ±0.20
Cable length	20 m
Cable jacket	PUR, Green
Shielding	Aluminum foil, tinned copper wire
Core insulation	TPE-O
Core cross-section	4 x 0.32 mm ²
Arrangement of strands	7 x 0.25 mm
Core colors	WH, YE, BU, OG
Electrical properties at +20 °C	
Rated voltage	30 V
Test voltage	2000 V
Current	4 A

Features



- M12 male connector, straight, D-coded
- End open
- Ethernet cable: 4-pin, AWG 22
- CAT 5E
- Jacket material: PUR
- Jacket color: green
- Shielding: overlapping aluminum foil, tinned copper wire
- Jacket diameter: 6.5 mm
- Suitable for drag chain use
- Oil resistant acc. to IEC 60811-2-1 and UL13
- Halogen free acc. to IEC 60754
- Flame retardant acc. to IEC 60332-1-2 and UL FT2
- RoHS compliant
- PNO compliant
- UL
- Cable length: 20 m

Cable Cross-Section

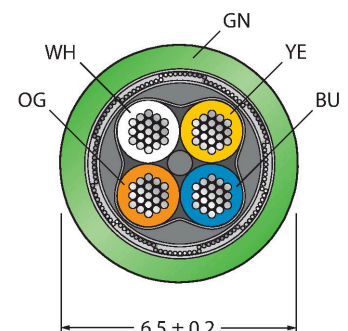

Technical data

DC resistance (loop)	120 Ω/km
Nom. impedance	100 Ω (1MHZ)
Nom. capacitance	50 pF/m
Mechanical and chemical properties	
Bending radius (stationary installation)	≥ 5 x Ø
Bending radius (flexible use)	≥ 15 x Ø
Bending cycles	≥ 5 million
Torsional stress	± 180 °/m
Torsion cycles	≤ 100,000 Cycles
Ambient temperature range (stationary)	-40...+80 °C
Ambient temperature range (In motion)	-30...+80 °C
Other Features	
Qualified for drag chain use	yes
Halogen-free	yes
PVC-free	yes
UV resistance	yes
Oil-resistant	yes
Flame-retardant	yes
Approvals	UL Listed

Contact assignment

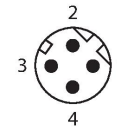

Circuit Diagram

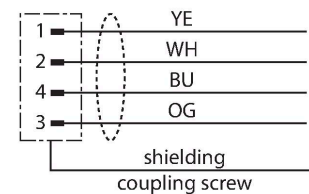



Accessories

TORQUE-WRENCH-SET-AS	6936170
Torque wrench set; handles with adjustable torque 0.4-1.0 Nm, torque wrench for M8 (SW9), fork wrench for M12 (SW 14)	

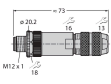
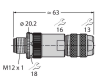
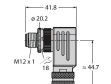
Accessories

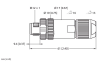
Dimension drawing	Type	ID	
	FW-M12ST5D-G-SB-ME-SH-8	6604218	Field-wireable male connector, M12 × 1, straight, 4-pin, screw terminal connection, cable feedthrough 5.0 to 8 mm, core cross-section/terminal capacity 0.14 to 0.75 mm ² , metal housing, metal coupling nut, shieldable, D-coded, for Ethernet
	CMBSD8141-0/PG9	6604282	Field-wireable male connector, M12 × 1, straight, 4-pin, screw terminal connection, cable feedthrough 6.0 to 8 mm, core cross-section/terminal capacity 0.14 to 0.75 mm ² , metal housing, metal nut, shieldable, D-coded, for Ethernet
	CMBSD8241-0/PG9	6604239	Field-wireable male connector, M12 × 1, angled, 4-pin, screw terminal connection, cable feedthrough 6.0 to 8 mm, core cross-section/terminal capacity 0.14 to 0.75 mm ² , metal housing, metal nut, shieldable, D-coded, for Ethernet

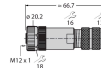
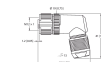
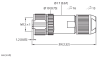
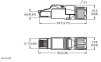
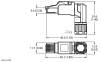
Dimension drawing	Type	ID	
	FW-ERSSM0426-FD-P-0408	100033307	Field-wireable male connector, M12 × 1, straight, 4-pin, shieldable, D-coded, push-in connection, cable feedthrough 4.0 to 8.0 mm, core cross-section/terminal capacity 0.14 to 0.75 mm ² , metal housing, metal coupling nut; PROFINET CAT5 (100 Mbps)
	FW-EWSSM0426-FD-P-0408	100033310	Field-wireable male connector, M12 × 1, angled, 4-pin, shieldable, D-coded, push-in connection, cable feedthrough 4.0 to 8.0 mm, core cross-section/terminal capacity 0.14 to 0.75 mm ² , metal housing, metal coupling nut; PROFINET CAT5 (100 Mbps)
	FW-M12KU5D-G-SB-ME-SH-8	6604219	Field-wireable female connector, M12 × 1, straight, 4-pin, screw terminal connection, cable feedthrough 5.0 to 8 mm, core cross-section/terminal capacity 0.14 to 0.75 mm ² , metal housing, metal nut, shieldable, D-coded, for Ethernet
	FW-EWKSM0426-FD-P-0408	100033308	Field-wireable female connector, M12 × 1, angled, 4-pin, shieldable, D-coded, push-in connection, cable feedthrough 4.0 to 8.0 mm, core cross-section/terminal capacity 0.14 to 0.75 mm ² , metal housing, metal coupling nut; PROFINET CAT5 (100 Mbit/s)
	FW-ERKSM0426-FD-P-0408	100033304	Field-wireable female connector, M12 × 1, straight, 4-pin, shieldable, D-coded, push-in connection, cable feedthrough 4.0 to 8.0 mm, core cross-section/terminal capacity 0.14 to 0.75 mm ² , metal housing, metal coupling nut; PROFINET CAT5 (100 Mbit/s)
	FW-RRSSP0822-IE-I-0510	100034569	Field-wireable male connector, RJ45, straight, 8-pin, IDC connection, cable feedthrough 5.5 mm to 10.0 mm, core cross-section/terminal capacity 0.14 mm ² to 0.34 mm ² , metal housing; CAT6A (10 Gigabit Ethernet acc. to IEEE 802.3an)
	FW-RWSSP0822-IE-I-0510	100034570	Field-wireable male connector, RJ45, angled, 8-pin, IDC connection, cable feedthrough 5.5 mm to 10.0 mm, core cross-section/terminal capacity 0.14 mm ² to 0.34 mm ² , metal housing; CAT6A (10 Gigabit Ethernet acc. to IEEE 802.3an)