

QS30EQPMA

Photoelectric Sensor – Opposed Mode Sensor (Emitter)

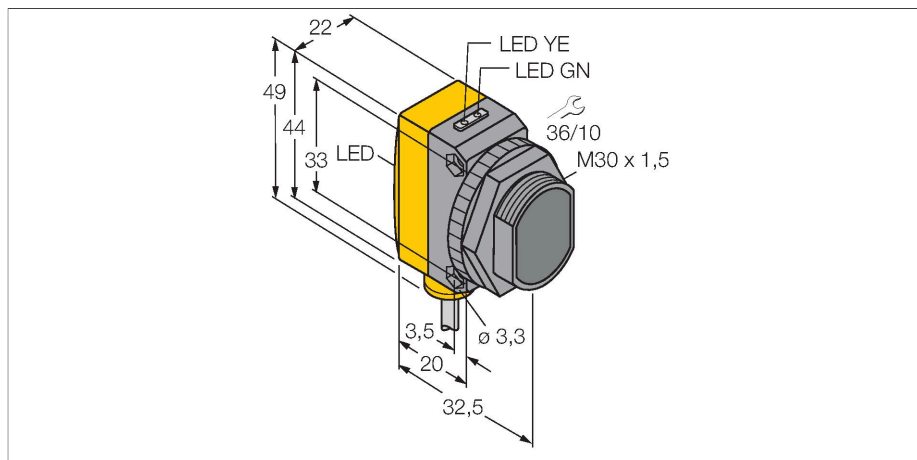

Technical data

Type	QS30EQPMA
ID no.	3073083
Optical data	
Function	Opposed mode sensor
Operating mode	Emitter
Light type	IR
Wavelength	875 nm
Range	0...60000 mm
Operating voltage	10...30 VDC
No-load current	≤ 70 mA
Readiness delay	≤ 100 ms
Response time typical	< 5 ms
Mechanical data	
Design	Rectangular with thread, QS30
Dimensions	Ø 30 x 35 x 22 x 49 mm
Housing material	Plastic, Thermoplastic material, Yellow
Lens	plastic, Acrylic
Electrical connection	Cable with connector, M12 × 1, 0.15 m, PUR
Number of cores	5
Ambient temperature	-20...+70 °C
Protection class	IP67
Power-on indication	LED, Green
Excess gain indication	LED
Tests/approvals	
MTTF	402 years acc. to SN 29500 (Ed. 99) 40 °C
Approvals	CE

Features

- Cable with male end M12 × 1, 5-pin, PUR, 150 mm
- Protection class IP67
- LED all-round visible

Wiring diagram

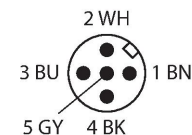

Functional principle

Opposed mode sensors consist of an emitter and receiver. They are installed opposite to each other so that the light from the emitter is aimed directly at the receiver. When an object interrupts or weakens the light beam, the sensor switches. Large distance operation is possible due to an excellent light/dark contrast and an extremely high excess gain.

Excess gain curve
Excess gain in relation to the distance

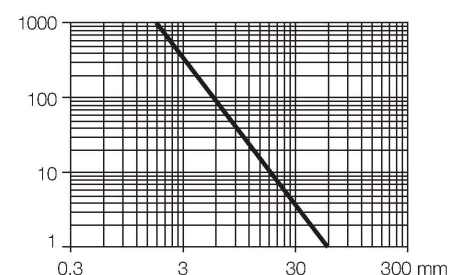

Accessories

SMB30A

3032723

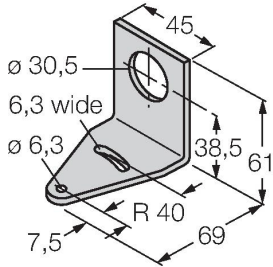

Mounting bracket, rectangular, stainless steel, for sensors with 30mm thread

SMBQS30L

3002809

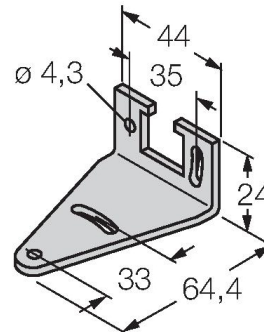

Mounting bracket, stainless steel, for QS30 series

SMB30MM

3027162

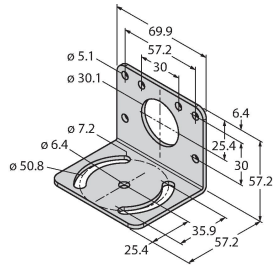

Mounting bracket, rectangular, stainless steel, for sensors with 30 mm thread, wide holes for accurate alignment

SMB30SC

3052521

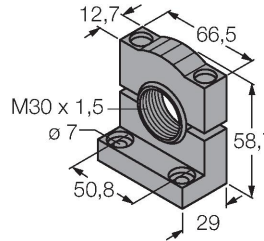

Mounting bracket, PBT black, for sensors with 30 mm thread, rotatable

Accessories

Dimension drawing

Type

ID no.

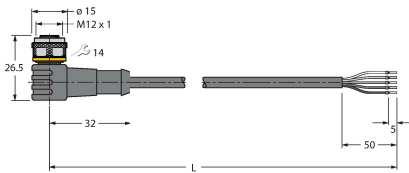

WKC4.5T-2/TEL

6625028

Connection cable, female M12, angled, 5-pin, cable length: 2 m, sheath material: PVC, black; cULus approval; other cable lengths and qualities available, see www.turck.com



RKC4.5T-2/TEL

6625016

Connection cable, female M12, straight, 5-pin, cable length: 2 m, sheath material: PVC, black; cULus approval; other cable lengths and qualities available, see www.turck.com