

# Q12AB6FF50 W/30

## Photoelectric Sensor – Diffuse Mode Sensor with Fixed-Field Background Suppression

### Miniature Sensor

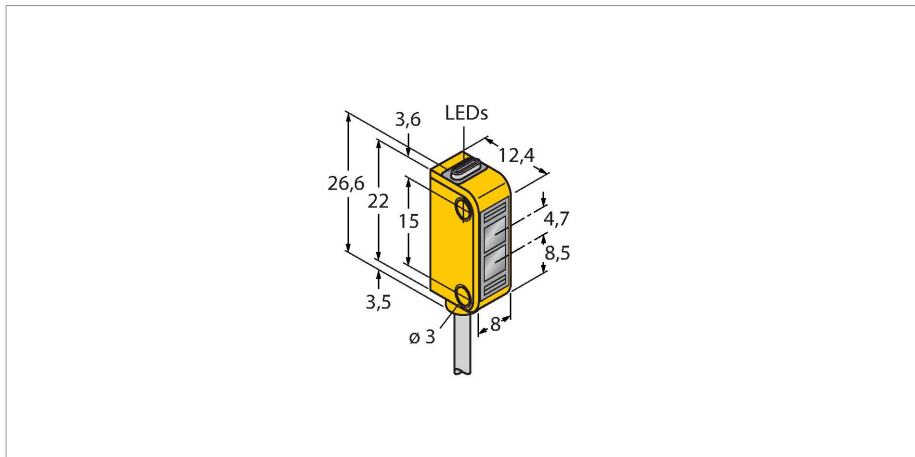

#### Technical data

Type	Q12AB6FF50 W/30
ID no.	3072118
<b>Optical data</b>	
Function	Proximity switch
Operating mode	Background suppression, non-adjustable
Light type	Red
Wavelength	640 nm
Range	3...50 mm
<b>Electrical data</b>	
Operating voltage	10...30 VDC
Residual ripple	< 10 % U <sub>ss</sub>
DC rated operational current	≤ 50 mA
No-load current	≤ 20 mA
Short-circuit protection	yes
Reverse polarity protection	yes
Output function	NO contact, PNP/NPN
Switching frequency	≤ 700 Hz
Readiness delay	≤ 120 ms
Response time typical	< 0.85 ms
<b>Mechanical data</b>	
Design	Rectangular, Q12
Dimensions	12.4 x 8 x 26.6 mm
Housing material	Plastic, Thermoplastic material, Yellow
Lens	plastic, Polycarbonate

#### Features

- Cable, PVC, 9 m
- Protection class IP67
- LED all-round visible
- Indication of insufficient excess gain
- Operating voltage: 10...30 VDC
- Switching output, bipolar, light operation

#### Wiring diagram

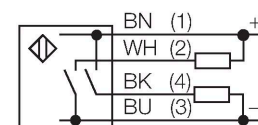

#### Functional principle

The emitter and receiver are incorporated in a single housing. The light reflection of the target is detected and triggers the sensor to switch. Thus the switching distance largely depends on the reflectivity of the target.

Excess gain curve

Excess gain in relation to the distance

## Technical data

Electrical connection	Cable, 9 m, PVC
Number of cores	3
Core cross-section	0.34 mm <sup>2</sup>
Ambient temperature	-20...+55 °C
Protection class	IP67
Power-on indication	LED, Green
Switching state	LED, Yellow
Error indication	LED, green
Excess gain indication	LED, yellow, flashing
<b>Tests/approvals</b>	
MTTF	135 years acc. to SN 29500 (Ed. 99) 40 °C
Approvals	CE, cURus

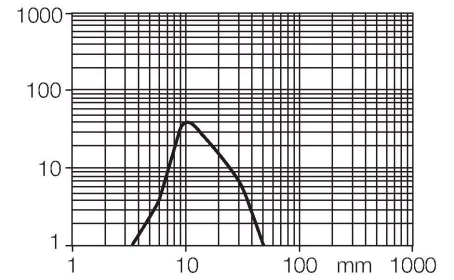

## Accessories

SMBQ12A

3074341

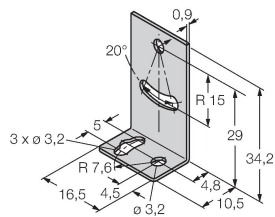

Mounting bracket; material VA 1.4401, for photoelectric sensor, Q12 series

SMBQ12T

3073722

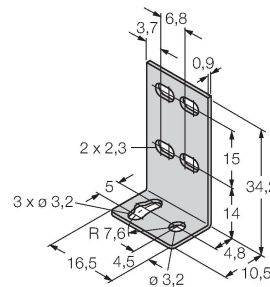

Mounting bracket; material VA 1.4401, for photoelectric sensor, Q12 series