

# WSC4T-2/TEL

## Actuator and Sensor Cable, PVC – Connection Cable

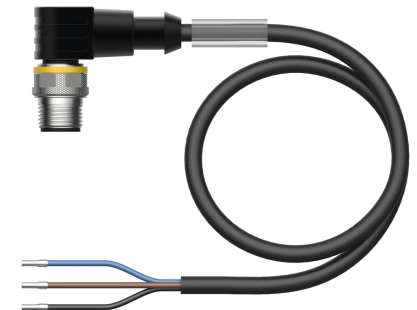
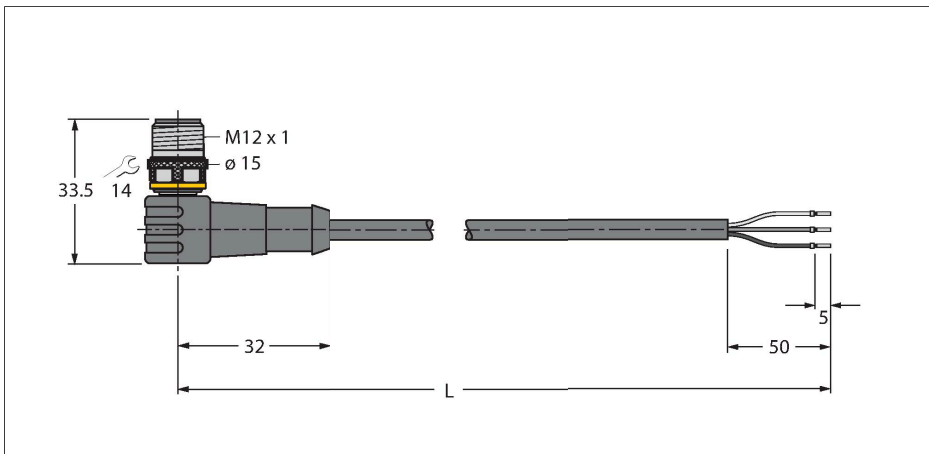

### Technical data

Type	WSC4T-2/TEL
ID	6625046
Connector A	Male, M12 × 1, Angled, A-coded
Number of Pins	3
Contacts	Brass, CuZn, Gold-plated
Contact carriers	Plastic, TPU, Black
Connector body	Plastic, TPU, Black
Coupling nut/screw	Brass, CuZn, Nickel-plated
Mechanical lifespan	> 100 Mating cycles
Pollution degree	3
Protection class	IP67, IP69K, Only in screwed condition
<b>Cable</b>	
Cable diameter	Ø 4.3 mm ±0.20
Cable length	2 m
Cable jacket	PVC, Black
Core insulation	PVC
Core cross-section	3 x 0.34 mm <sup>2</sup>
Arrangement of strands	42 x 0.1 mm
Core colors	BN, BU, BK
<b>Electrical properties at +20 °C</b>	
Rated voltage	250 V
Test voltage	2000 V
Current	4 A
Insulation resistance	> 30.5 MΩ/km
forward resistance	max. 57 Ω/km
<b>Mechanical and chemical properties</b>	
Bending radius (stationary installation)	≥ 5 x Ø

### Features



- Male M12, angled, 3-pin
- Jacket material: PVC
- Jacket color: black
- Resistant to chemicals and oils
- Flame retardant
- Resistant to acids and alkaline solutions
- Resistant to microbes and hydrolysis
- LABS free
- Protection class: IP67, IP69K
- Cable length: 2.0 m

### Cable Cross-Section

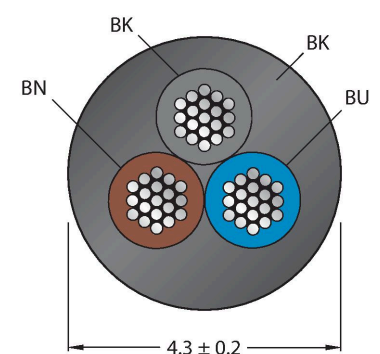

### Contact assignment

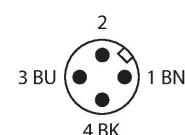

## Technical data

Bending radius (flexible use)	$\geq 10 \times \varnothing$
Ambient temperature range (stationary)	-40...+105 °C
Ambient temperature range (In motion)	-5...+80 °C
Approvals	cULus

## Circuit Diagram

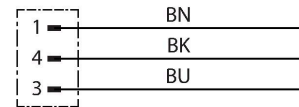

## Accessories

HA8141-0 6905407

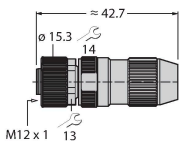

Field-wireable female connector, M12 × 1, straight, 4-pin, insulation piercing connection, cable feedthrough 4.0 to 5.1 mm, core cross-section/terminal capacity 0.14 to 0.34 mm<sup>2</sup>, plastic housing, metal nut

HA8241-0 6905401

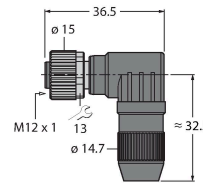

Field-wireable female connector, M12 × 1, angled, 4-pin, insulation piercing connection, cable feedthrough 4.0 to 5.1 mm, core cross-section/terminal capacity 0.14 to 0.34 mm<sup>2</sup>, plastic housing, metal nut

B8141-0 69049

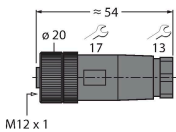

Field-wireable female connector, M12 × 1, straight, 4-pin, screw terminal connection, cable feedthrough 4.0 to 6.0 mm, core cross-section/terminal capacity 0.14 to 0.75 mm<sup>2</sup>, plastic housing, plastic nut

B8241-0 69048

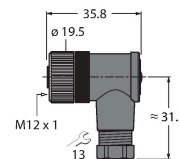

Field-wireable female connector, M12 × 1, angled, 4-pin, screw terminal connection, cable feedthrough 4.0 to 6.0 mm, core cross-section/terminal capacity 0.14 to 0.75 mm<sup>2</sup>, plastic housing, plastic nut

BM8141-0 6935145

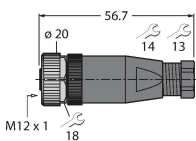

Field-wireable female connector, M12 × 1, straight, 4-pin, screw terminal connection, cable feedthrough 4.0 to 6.0 mm, core cross-section/terminal capacity 0.25 to 0.75 mm<sup>2</sup>, plastic housing, metal nut

BM8241-0 6935889

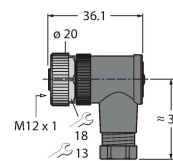

Field-wireable female connector, M12 × 1, angled, 4-pin, screw terminal connection, cable feedthrough 4.0 to 6.0 mm, core cross-section/terminal capacity 0.25 to 0.75 mm<sup>2</sup>, plastic housing, metal nut

TORQUE-WRENCH-SET-AS 6936170

Torque wrench set; handles with adjustable torque 0.4-1.0 Nm, torque wrench for M8 (SW9), fork wrench for M12 (SW 14)

BLANK-LABEL-FOR-CORDSETS-TEL-TXL 6936206

Label for TEL and TXL cables, length: 18 mm, height: 4 mm, material: polycarbonate (PC), color: white, halogen-free and flame-retardant

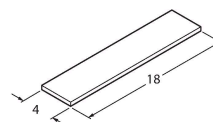

## Accessories

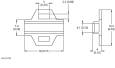
Dimension drawing	Type	ID	
	LABEL-HOLDER-FLEX-PVC	100048170	PVC label holder for identification of extension cables (TEL/TXL product series); for cable diameters: min. 5 mm; dimensions 4 × 18 mm; delivery unit: 50 pcs. per package