

QS18VP6LD W/30'

Photoelectric Sensor – Diffuse Mode Laser Sensor

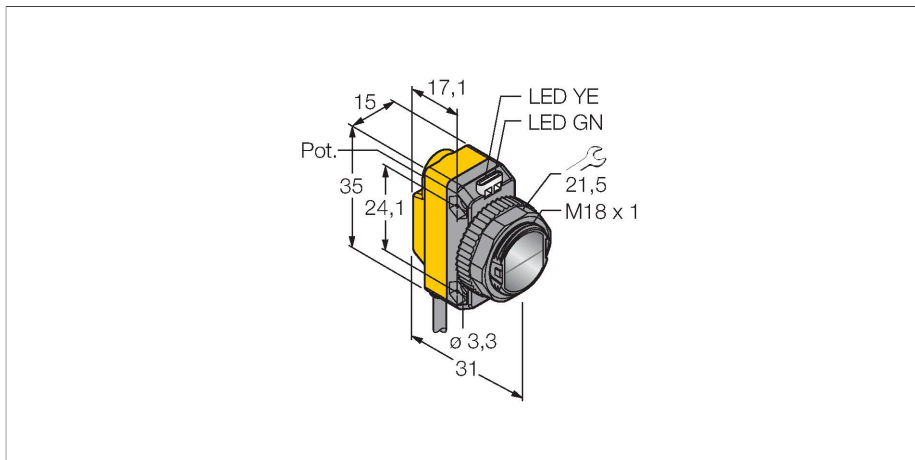

Technical data

| | |
|------------------------------|-------------------------------|
| Type | QS18VP6LD W/30' |
| ID no. | 3073041 |
| Optical data | |
| Function | Proximity switch |
| Operating mode | Diffuse |
| Light type | Red |
| Wavelength | 650 nm |
| Laser class | ▲ 1 |
| Beam diameter | 1 mm at 300 mm |
| Range | 0...300 mm |
| Electrical data | |
| Operating voltage | 10...30 VDC |
| Residual ripple | < 10 % U _{ss} |
| DC rated operational current | ≤ 100 mA |
| Short-circuit protection | yes |
| Reverse polarity protection | yes |
| Output function | NO/NC, PNP |
| Current output | 100 mA |
| Switching frequency | ≤ 700 Hz |
| Readiness delay | ≤ 200 ms |
| Response time typical | < 0.7 ms |
| Setting option | Potentiometer |
| Mechanical data | |
| Design | Rectangular with thread, QS18 |
| Dimensions | Ø 18 x 31 x 15 x 35 mm |
| Housing material | Plastic, ABS |
| Lens | plastic, Acrylic |

Features

- Cable, PVC, 9 m
- Protection class IP67
- LED all-round visible
- Sensitivity adjusted via potentiometer
- Operating voltage: 10...30 VDC
- PNP switching output, changeover

Wiring diagram

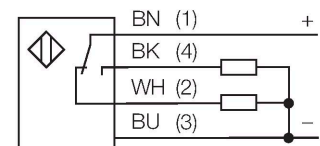

Functional principle

Identical to retro-reflective sensors, emitter and receiver circuitry are incorporated in the same housing of the diffuse mode sensors. However, diffuse mode sensors do not detect the interruption of the light beam but the reflection of the target. A target is detected if it reflects sufficient light back to the receiver. The switching distance of diffuse mode sensors thus largely depends on the reflectivity of the target.

Excess gain curve
Excess gain in relation to the distance

Technical data

| | |
|------------------------|--|
| Electrical connection | Cable, 9 m, PVC |
| Number of cores | 4 |
| Core cross-section | 0.35 mm ² |
| Ambient temperature | -10...+50 °C |
| Protection class | IP67 |
| Special features | Laser |
| Power-on indication | LED, Green |
| Switching state | LED, Yellow |
| Error indication | LED, green, Flashing |
| Excess gain indication | LED, yellow, flashing |
| Tests/approvals | |
| MTTF | 17 years acc. to SN 29500 (Ed. 99) 40 °C |
| Approvals | CE, cURus |

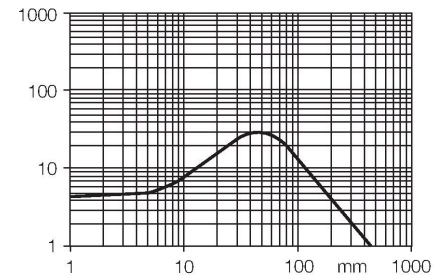

Accessories

SMB18A

3033200

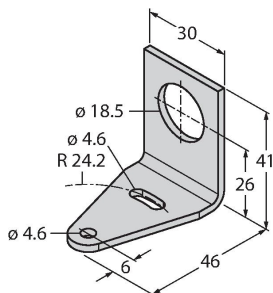

Mounting bracket, rectangular, stainless steel, for sensors with 18 mm thread

SMB18AFAM10

3012558

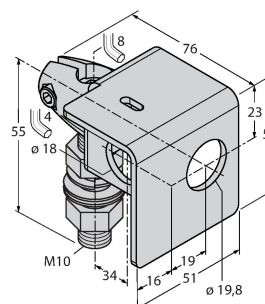

Mounting bracket, material VA 1.4401, for M10 x 1.5 thread, thread length 18 mm

SMBQS18A

3069721

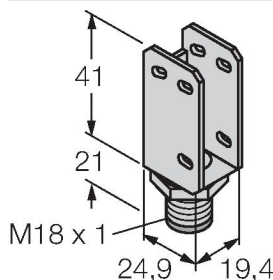

Mounting bracket, stainless steel, for 18 mm thread

SMB18SF

3052519

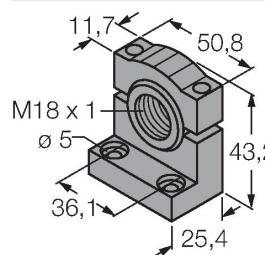

Mounting bracket, PBT black, for sensors with 18 mm thread, rotatable