

RSC12T-2/TEG

Actuator and Sensor Cable, PVC – Connection Cable

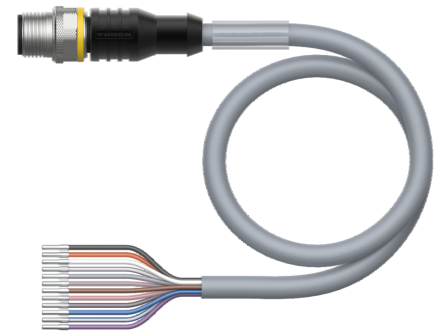
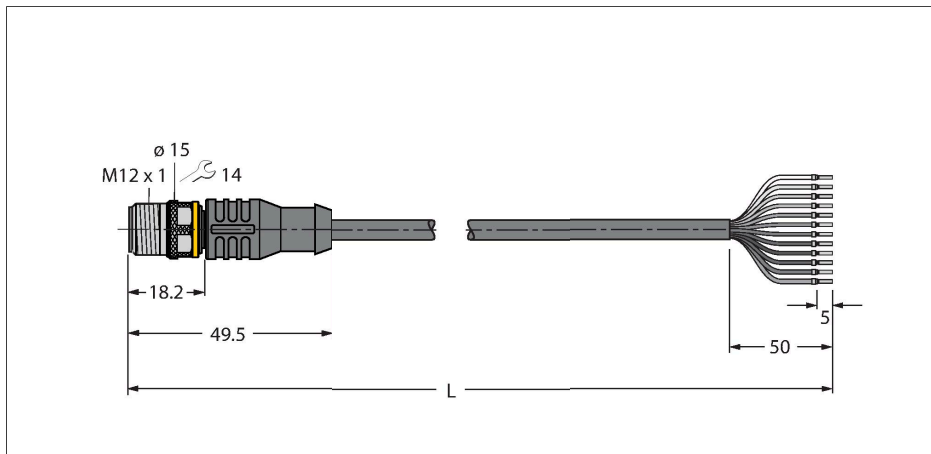

Technical data

Type	RSC12T-2/TEG
ID	6629332
Connector A	Male, M12 × 1, Straight, A-coded
Number of Pins	12
Contacts	Brass, CuZn, Gold-plated
Contact carriers	Plastic, TPU, Black
Connector body	Plastic, TPU, Black
Coupling nut/screw	Brass, CuZn, Nickel-plated
Mechanical lifespan	> 100 Mating cycles
Pollution degree	3
Protection class	IP67, IP69K, Only in screwed condition
Cable	
Cable diameter	Ø 5.9 mm ±0.20
Cable length	2 m
Cable jacket	PVC, Gray
Core insulation	PVC
Core cross-section	12 x 0.14 mm ²
Arrangement of strands	18 x 0.1 mm
Core colors	BN, WH, BU, BK, GY, PK, VT, OG, GY/ PK, WH/BU, WH/GY, GY/BN
Electrical properties at +20 °C	
Rated voltage	30 V
Test voltage	2000 V
Current	1.5 A
Insulation resistance	> 30.5 MΩ/km
forward resistance	max. 138 Ω/km
Mechanical and chemical properties	
Bending radius (stationary installation)	≥ 5 x Ø

Features



- Male M12, straight, 12-pin
- Jacket material: PVC
- Jacket color: gray
- Resistant to chemicals and oils
- Flame retardant
- Resistant to acids and alkaline solutions
- Resistant to microbes and hydrolysis
- LABS free
- Protection class: IP67, IP69K
- Cable length: 2.0 m

Cable Cross-Section

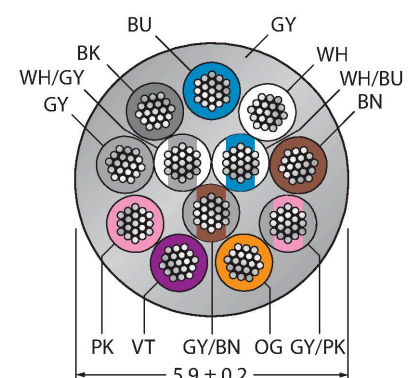

Contact assignment

Technical data

Bending radius (flexible use)	≥ 10 x Ø
Ambient temperature range (stationary)	-40...+105 °C
Ambient temperature range (In motion)	0...+80 °C
Approvals	cULus

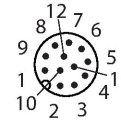

Functional principle

Drawing shows design status including hexagon coupling nut (Production start CW11/2016).
Wiring diagram shows contact assignment acc. to DIN EN 60947-5-2 (Production start CW16/2017).

Circuit Diagram

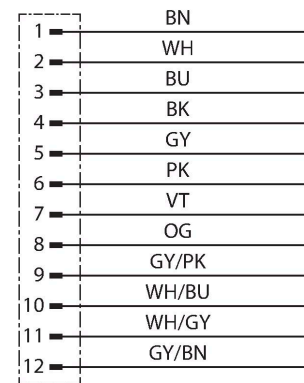

Stranded Wire Colors

Pin	DIN 47100 (old)	DIN EN 60947-5-2 (new)
1	BN	BN
2	BU	WH
3	WH	BU
4	GN	BK
5	PK	GY
6	YE	PK
7	BK	VT
8	GY	OG
9	RD	GY/PK
10	VT	WH/BU
11	GY/PK	WH/GY
12	RD/BU	GY/BN

Accessories

TORQUE-WRENCH-SET-AS

6936170

Torque wrench set; handles with adjustable torque 0.4-1.0 Nm, torque wrench for M8 (SW9), fork wrench for M12 (SW 14)

BLANK-LABEL-FOR-CORDSETS-TEL-TXL

6936206

Label for TEL and TXL cables, length: 18 mm, height: 4 mm, material: polycarbonate (PC), color: white, halogen-free and flame-retardant

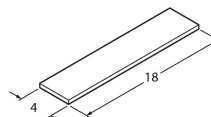

B81121-0/PG9

6604052

Field-wireable female connector, M12 × 1, straight, 12-pin, solder contact, cable feedthrough 6.0 to 8.0 mm, core cross-section/terminal capacity 0.14 to 0.25 mm², plastic housing, metal nut

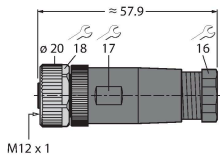

Accessories

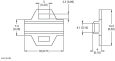
Dimension drawing	Type	ID	
	LABEL-HOLDER-FLEX-PVC	100048170	PVC label holder for identification of extension cables (TEL/TXL product series); for cable diameters: min. 5 mm; dimensions 4 × 18 mm; delivery unit: 50 pcs. per package