

**Set for I/O Communication via Profibus DPV1 in IP67  
TI-BL67-DPV1-S-8**

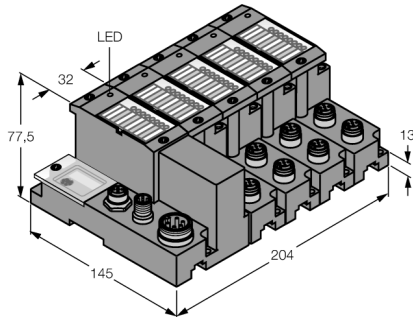

- A special software (function module) for integration in PLC systems is not required.
- User data, 8 byte per read/write cycle
- Cable max. 50 m between interface and read/write head
- 3 decimal rotary coding switches for the adjustment of the Profibus address
- Maximum transmission rate to the fieldbus 12 Mbps
- Two males M12 x 1, 5-pin reverse-keyed, for fieldbus connection
- One male 7/8", 5-pin, for power supply
- LEDs for display of supply voltage, group and bus errors as well as status and diagnostics
- Connection of up to 8 read/write heads via BL ident M12 extension cables
- Mixed operation of HF and UHF read/write heads

**Wiring Diagram**

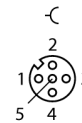

**PROFIBUS-DP OUT**

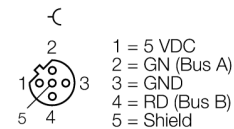

**PROFIBUS-DP**

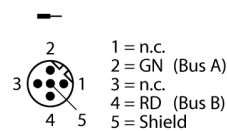

**Power Supply**

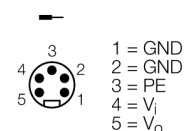

<b>Type designation</b>	TI-BL67-DPV1-S-8
Ident no.	1545109
Number of channels	8
Dimensions (W x L x H)	204 x 145 x 77.5 mm
<b>Supply voltage</b>	24 VDC
max. system supply current $I_{mb(SV)}$	1.5, A
Max. sensor supply $I_{sens}$	4 A electronically limited current supply electronically limited current supply
max. load current $I_o$	10 A
Admissible range	18...30 VDC
<b>Fieldbus transmission rate</b>	9.6 kbps ...12 Mbps
Fieldbus address range	1...125
Fieldbus addressing	3 decimally coded rotary switches
Service interface	RS232 interface (PS/2 socket)
Fieldbus connection technology	2 x M12, 5-pin, reverse-coded
Voltage supply connection	5-pin male 7/8" connector
Fieldbus termination	external
<b>Transmission rate</b>	115.2 kbps
Electrical isolation	isolation of electronics and field level via opto-couplers
<b>Output connectivity</b>	M12
<b>Sensor supply</b>	0.5 A per channel, short-circuit proof
<b>Temperature derating</b>	&#x0020;
> 55 °C Circulating air (Ventilation)	no limitation
> 55 °C Steady ambient air	$I_{sens} < 3A, I_{mb} < 1A$
Relative humidity	5...95 % (internal), level RH-2, no condensation (when stored at 45 °C)
Vibration test	Acc. to EN 61131
Extended vibration resistance	VN 02-00 and higher
- up to 5 g (at 10 to 150 Hz)	for mounting on DIN rail no drilling according to EN 60715, with end bracket
- up to 20 g (at 10 up to 150 Hz)	for mounting on base plate or machinery Therefore every second module has to be mounted with two screws each.
Shock test	Acc. to IEC 60068-2-27
Drop and topple	acc. to IEC 68-2-31 and free fall to IEC 68-2-32
Electromagnetic compatibility	Acc. to EN 61131-2
Protection class	IP67

## Set for I/O Communication via Profibus DPV1 in IP67 TI-BL67-DPV1-S-8

---

Included in delivery

1 x end plate BL67

### Functional principle

BL ident can be integrated into your plant structure in many different ways.

Various fieldbus standards, such as PROFIBUS-DP, EtherNet/IP, Ethernet Modbus TCP, EtherCAT, DeviceNet, CANopen and PROFINET IO allow flexible integration.

BL ident simple electronic modules (BL20-2RFID-S, BL67-2RFID-S) can be integrated into existing control or host systems without function block, since standard input/output process data is used for communication.

Programmable gateways with peripheral pre-processing function relieve the control system and fieldbus level.

Preassembled sets (2, 4, 6 or 8-port), easily mounted, available for all fieldbus networks.

**Set for I/O Communication via Profibus DPV1 in IP67  
TI-BL67-DPV1-S-8**

**Compatible base modules**

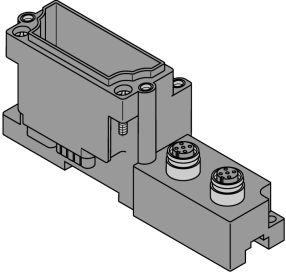
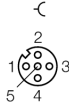
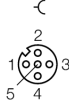
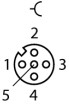
Dimension drawing	Type	Pin configuration
	<p>BL67-B-2M12 6827186 2 x M12, 5-pole, female, a-coded</p>	<p><b>.../S2500 Connectors</b></p>  <ul style="list-style-type: none"> <li>1 = BN (+)</li> <li>2 = BK (Data)</li> <li>3 = BU (GND)</li> <li>4 = WH (Data)</li> <li>5 = shield</li> </ul> <p><b>.../S2501 Connectors</b></p>  <ul style="list-style-type: none"> <li>1 = BN (+)</li> <li>2 = WH (Data)</li> <li>3 = BU (GND)</li> <li>4 = BK (Data)</li> <li>5 = shield</li> </ul> <p><b>Connectors .../S2503</b></p>  <ul style="list-style-type: none"> <li>1 = RD (+)</li> <li>2 = BU (Data)</li> <li>3 = BK (GND)</li> <li>4 = WH (Data)</li> <li>5 = shield</li> </ul>

## Set for I/O Communication via Profibus DPV1 in IP67

### TI-BL67-DPV1-S-8

#### LED display

LED	Color	Status	Meaning
D		OFF	No error message or diagnostics active.
	RED	ON	Failure of module bus communication. Check if more than 2 adjacent electronic modules are pulled. Relevant modules are located between gateway and this module.
	RED	FLASHING (0.5 Hz)	Upcoming module diagnostics
RW0 / RW1		OFF	No tag, no active diagnostics
	GREEN	ON	Tag available
	GREEN	FLASHING (2 Hz)	Data exchange with tag enabled
	RED	ON	Read/write head error
	RED	FLASHING (2 Hz)	Short-circuit in the supply line of read/write head

## Set for I/O Communication via Profibus DPV1 in IP67

### TI-BL67-DPV1-S-8

#### I/O Data Mapping

INPUT	BYTE	Bit 7	Bit 6	Bit 5	Bit 4	Bit 3	Bit 2	Bit 1	Bit 0
Channel 0	0	DONE	BUSY	ERROR	XCVR CON	XCVR ON	TP	TFR	Reserved
	1	Error Code							
	2	Error Code 1							
	3	Reserved							
	4	READ DATA (8 Byte)							
	5								
	...								
	10								
	11								
Channel 1	12	DONE	BUSY	ERROR	XCVR CON	XCVR ON	TP	TFR	Reserved
	13	Error Code							
	14	Error Code 1							
	15	Reserved							
	16	READ DATA (8 Byte)							
	17								
	...								
	22								
	23								
OUTPUT	BYTE	Bit 7	Bit 6	Bit 5	Bit 4	Bit 3	Bit 2	Bit 1	Bit 0
Channel 0	0	XCVR	NEXT	TAG ID	READ	WRITE	TAG INFO	XCVR INFO	RESET
	1	Reserved					Byte Count 2	Byte Count 1	Byte Count 0
	2	Address high byte							
	3	Address low byte							
	4	WRITE DATA (8 Byte)							
	5								
	...								
	10								
	11								
Channel 1	12	XCVR	NEXT	TAG ID	READ	WRITE	TAG INFO	XCVR INFO	RESET
	13	Reserved					Byte Count 2	Byte Count 1	Byte Count 0
	14	Address high byte							
	15	Address low byte							
	16	WRITE DATA (8 Byte)							
	17								
	...								
	22								
	23								

**Set for I/O Communication via Profibus DPV1 in IP67  
TI-BL67-DPV1-S-8**

**Accessories**

Type code	Ident no.		Dimension drawing
RKM52-6M	6914145	Power supply cable, 7/8" female connector, straight, 4-pin + PE, cable length: 6 m, jacket material: PUR, gray	
RSM-2RKM50	6914950	Power supply T-splitter, 1 x 7/8" male, 2 x 7/8" female, 5-pin, ampacity: 9 A, Rated voltage: 250 V, Temperature: -40 °C ...+80 °C, wired in parallel	