

RJ45S-RJ45S-4416-7.5M

Industrial Ethernet/PROFINET Cable – Extension Cable

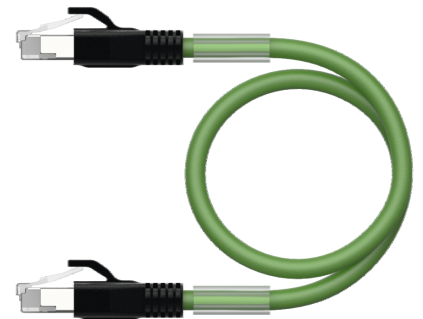
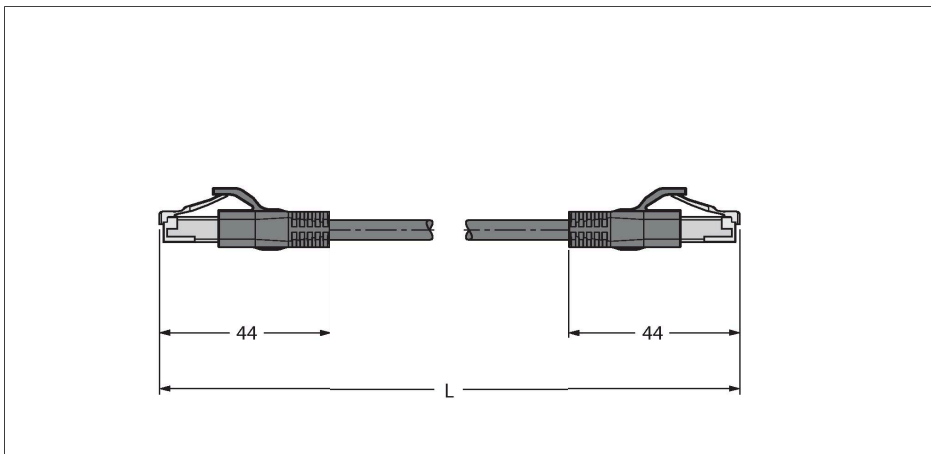

Technical data

Type	RJ45S-RJ45S-4416-7.5M
ID	6441618
Connector A	Male, RJ45, Straight
Number of Pins	4
Contacts	Metal, CuZn, Gold-plated
Contact carriers	Plastic, PC
Connector body	Plastic, TPU, Black
Mechanical lifespan	> 100 Mating cycles
Pollution degree	3/2
Protection class	IP20
Connector B	Male, RJ45, Straight
Number of pins	4
Contacts	Metal, CuZn, Gold-plated
Contact carriers	Plastic, PC
Connector body	Plastic, TPU, UL 94
Mechanical life	> 100 Mating cycles
Pollution degree	3/2
Protection class	IP20
Cable	
Network protocol	Ethernet
Cable diameter	Ø 6.5 mm ±0.20
Cable length	7.5 m
Cable jacket	PUR, Green
Shielding	Aluminum foil, tinned copper wire
Core insulation	PE
Core cross-section	4 x 0.32 mm ²
Arrangement of strands	7 x 0.25 mm

Features



- RJ45 male connector, straight, 4-pin
- RJ45 male connector, straight, 4-pin
- Ethernet cable: 4-pin, AWG 22
- CAT 5E
- Jacket material: PUR
- Jacket color: green
- Shielding: overlapping aluminum foil, tinned copper wire
- Jacket diameter: 6.5 mm
- Suitable for drag chain use
- Oil resistant acc. to IEC 60811-2-1 and UL13
- Halogen free acc. to IEC 60754
- Flame retardant acc. to IEC 60332-1-2 and UL2556 VW1
- Approval: UL
- RoHS compliant
- PNO compliant
- Cable length: 7.5 m

Cable Cross-Section

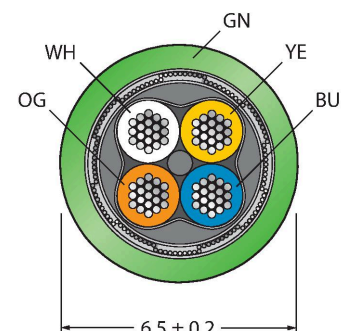

Technical data

Core colors	WH, YE, BU, OG
Electrical properties at +20 °C	
Rated voltage	48 V
Test voltage	2000 V
Current	3 A
DC resistance (loop)	120 Ω/km
Nom. impedance	100 Ω (1MHZ)
Nom. capacitance	50 pF/m
Mechanical and chemical properties	
Bending radius (stationary installation)	≥ 5 x Ø
Bending radius (flexible use)	≥ 8 x Ø
Bending cycles	≥ 3 million
Torsional stress	± 180 °/m
Torsion cycles	≤ 100,000 Cycles
Ambient temperature range (stationary)	-50...+70 °C
Ambient temperature range (In motion)	-20...+60 °C
Other Features	
Qualified for drag chain use	yes
Halogen-free	yes
PVC-free	yes
UV resistance	yes
Oil-resistant	yes
Flame-retardant	yes
Approvals	UL Listed

Contact assignment



Circuit Diagram

