

QS186LE2Q8

Photoelectric Sensor – Laser Emitter

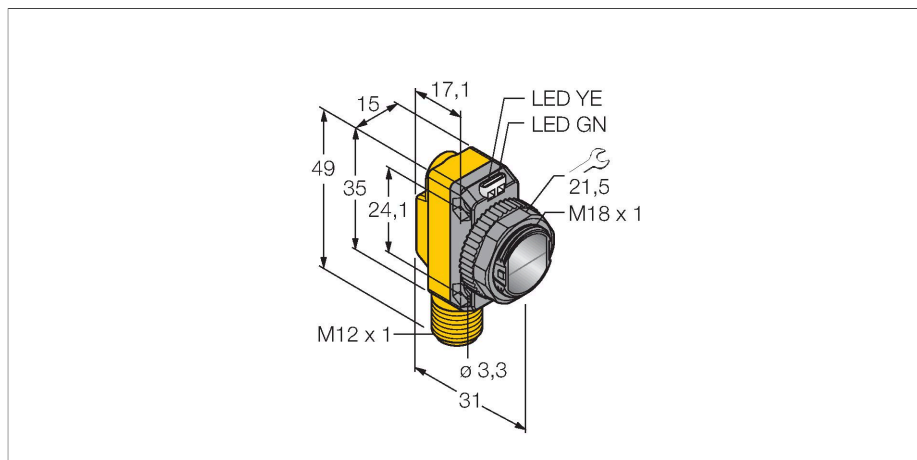

Technical data

Type	QS186LE2Q8
ID no.	3074733
Optical data	
Function	Opposed mode sensor
Operating mode	Laser Emitter
Light type	IR
Wavelength	650 nm
Laser class	▲ 2
Range	0...15000 mm
Electrical data	
Operating voltage	10...30 VDC
Residual ripple	< 10 % U _{ss}
DC rated operational current	≤ 100 mA
Short-circuit protection	yes
Reverse polarity protection	yes
Readiness delay	≤ 0.01 s
Readiness delay	≤ 10 ms
Mechanical data	
Design	Rectangular with thread, QS18
Dimensions	Ø 18 x 31 x 15 x 35 mm
Housing material	Plastic, ABS
Lens	plastic, PMMA
Electrical connection	Connectors, M12 × 1, PVC
Number of cores	4
Ambient temperature	-10...+50 °C
Protection class	IP67
Special features	Laser

Features

- Male M12 × 1, 4-pin
- Protection class IP67
- LED all-round visible
- Male M12 × 1
- Laser class 2

Wiring diagram

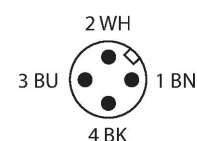
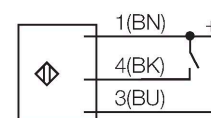

Functional principle

Opposed mode sensors consist of an emitter and a receiver. They are installed opposite to each other whereby the emitted light aims directly at the receiver. When an object interrupts or weakens the light beam, the sensor switches. Opposed mode sensors are the most reliable photoelectric sensors for detection of opaque objects. The high light/dark contrast and the very high excess gain are typical for this function mode and enable operation over large distances and under difficult conditions.

Activation

By connecting the control input (PIN 2 WH) to ground (-) the laser beam is turned on. The laser beam is turned off again by feeding 10 ... 30 VDC to the control input or by non-connecting the wire.

Technical data

Power-on indication	LED, Green
Excess gain indication	LED
Tests/approvals	
MTTF	530 years acc. to SN 29500 (Ed. 99) 40 °C
Approvals	CE

Excess gain curve
Excess gain in relation to the distance (type 6EB/RB)

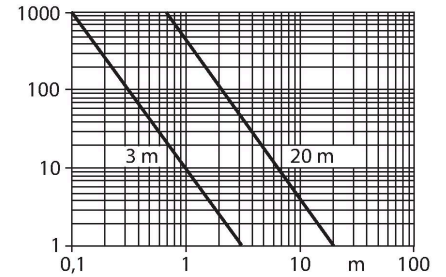

Accessories

SMB18A

3033200

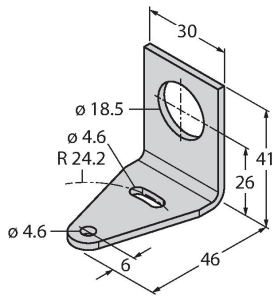

Mounting bracket, rectangular, stainless steel, for sensors with 18 mm thread

SMB18AFAM10

3012558

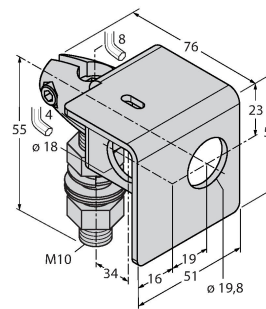

Mounting bracket, material VA 1.4401, for M10 x 1.5 thread, thread length 18 mm

SMBQS18A

3069721

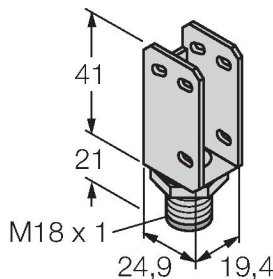

Mounting bracket, stainless steel, for 18 mm thread

SMB18SF

3052519

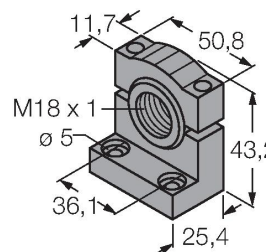

Mounting bracket, PBT black, for sensors with 18 mm thread, rotatable

Accessories

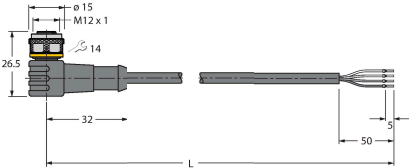
Dimension drawing	Type	ID no.	
	RKC4.4T-2/TEL	6625013	Connection cable, female M12, straight, 4-pin, cable length: 2 m, sheath material: PVC, black; cULus approval; other cable lengths and qualities available, see www.turck.com
	WKC4.4T-2/TEL	6625025	Connection cable, female M12, angled, 4-pin, cable length: 2 m, sheath material: PVC, black; cULus approval; other cable lengths and qualities available, see www.turck.com