

SLPMR14-830P12

Safety Technology – Receiver

Integrated Muting Function

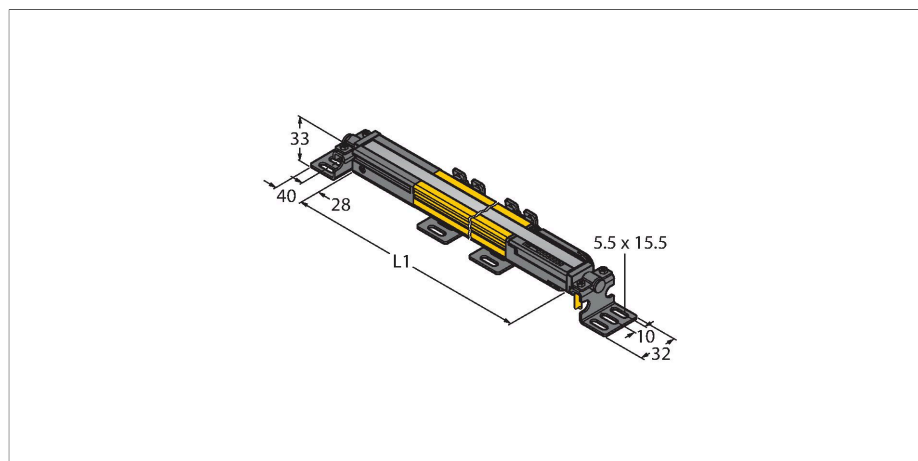

Features

- Cable with male end M12 x 1, 8-pin, 300 mm
- Protection class IP65
- Flat housing without blind zone
- Adjustments via DIP switch
- Resolution can be reduced
- Blanking function
- Operating voltage: 24 VDC \pm 15 %
- Resolution 14 mm
- Scan field 830 mm (L1)
- Mounting bracket included in delivery

Wiring diagram

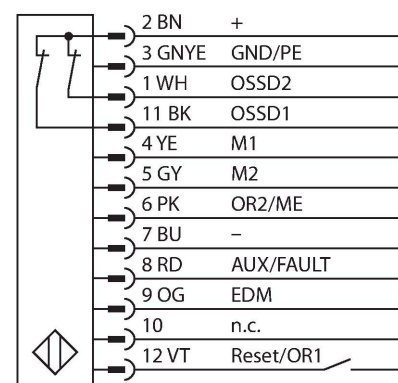

Functional principle

The high-resolution safety light screen is emitter and receiver in one without blind zone. As the system is optically synchronized, emitter/receiver wiring is superfluous. The receiver's safety switching outputs are directly connected to a load relay (e.g. IM-T-9A) and trigger an immediate stop of dangerous machine cycles. Personnel safety category PLe acc. to ISO 13849-1 is fulfilled through 2-channel monitoring of the switching device and the principle of diverse redundancy by which two processors control each other mutually.

Technical data

Type	SLPMR14-830P12
ID no.	3084456
Optical data	
Function	Light screen
Optical resolution	14 mm
Range	0...7000 mm
Scan field	830 mm
Number of beams	83
With muting function	yes
Scan Code	Adjustable
Electrical data	
Operating voltage	20...28 VDC
Residual ripple	< 10 % U_{ss}
DC rated operational current	\leq 150 mA
Current consumption non-actuated	\leq 150 mA
No-load current	\leq 275 mA
Max. current safe output	0.5 mA
Short-circuit protection	yes
Reverse polarity protection	yes
Output function	2 x NC (normally closed), 2 x PNP
Current output	0...500 mA
Number of safe semiconductor outputs	2
Response time typical	< 22.5 ms
With restart interlock	yes
Blanking function	yes

Technical data

Mechanical data	
Design	Rectangular, EZ-Screen LP
Dimensions	26 x 28 x 829 mm
Housing material	Metal, AL, Yellow polyester
Lens	plastic, Acryl
Cascadable	no
Electrical connection	Cable with connector, M12 × 1, 0.3 m
Number of cores	12
Ambient temperature	0...+55 °C
Protection class	IP65
Power-on indication	LED, Green
Switching state	2-color LED, Red
Tests/approvals	
Vibration resistance	10–55 Hz at 0.35 mm
Shock test	10 g at 16 ms (6000 cycles)
Approvals	CE, cTUVus