

BIM-NST-Y1X

Magnetic Field Sensor – For Pneumatic Cylinders

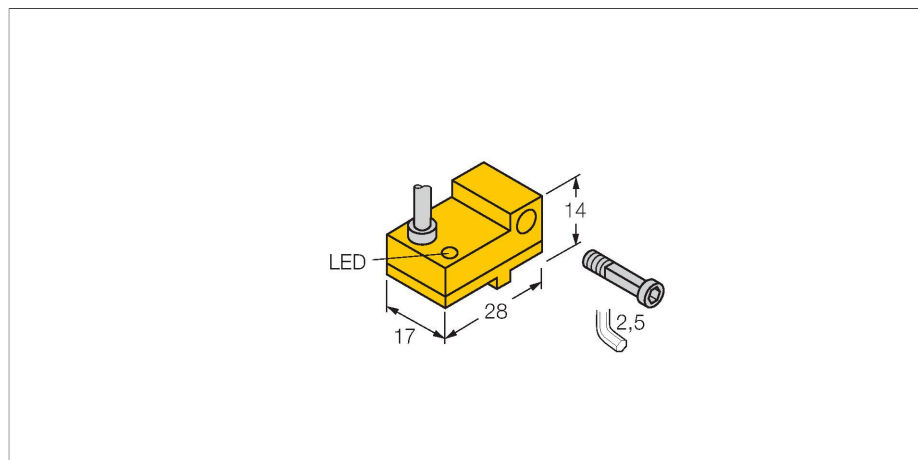

Features

- Plastic, PA12-GF30
- Magnetic-inductive sensor
- DC 2-wire, nom. 8.2 VDC
- Output acc. to DIN EN 60947-5-6 (NAMUR)
- Cable connection
- ATEX category II 2 G, Ex Zone 1
- ATEX category II 1 D, Ex Zone 20
- SIL 2 (Low Demand Mode) acc. to IEC 61508, PL c acc. to ISO 13849-1 at HFT0
- SIL 3 (All Demand Mode) acc. to IEC 61508, PL e acc. to ISO 13849-1 with redundant configuration HFT1

Technical data

Type	BIM-NST-Y1X
ID	1058400
General data	
Pass speed	≤ 10 m/s
Repeatability	≤ ± 0.1 mm
Temperature drift	≤ 0.1 mm
Hysteresis	≤ 1 mm
Electrical data	
Output function	2-wire, NAMUR
Switching frequency	1 kHz
Voltage	Nom. 8.2 VDC
Current consumption non-actuated	≤ 1.2 mA
Actuated current consumption	≥ 2.1 mA
Approval acc. to	KEMA 02 ATEX 1090X
Internal capacitance (C _i)/inductance (L _i)	150 nF/150 µH
Device marking	Ex II 2 G Ex ia IIC T6 Gb/II 1 D Ex ia III C T135 °C Da (max. U _i = 20 V, I _i = 60 mA, P _i = 130 mW)
Mechanical data	
Design	Rectangular, NST
Dimensions	28 x 17 x 14 mm
Housing material	Plastic, PA12-GF30
Active area material	Plastic, PA12-GF30
Electrical connection	Cable
Cable quality	Ø 5.2 mm, Blue, LifYY, PVC, 2 m
Core cross-section	2 x 0.34 mm ²

Wiring diagram

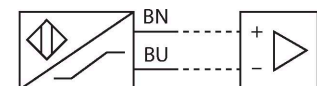



Functional principle

Magnetic field sensors are activated by magnetic fields and are especially suited for piston position detection in pneumatic cylinders. Based on the fact that magnetic fields can permeate non-magnetizable metals, it is possible to detect a permanent magnet attached to the piston through the aluminium wall of the cylinder.

Technical data

Environmental conditions	
Ambient temperature	-25...+70 °C
Vibration resistance	55 Hz (1 mm)
Shock resistance	30 g (11 ms)
Protection class	IP67
MTTF	6198 years acc. to SN 29500 (Ed. 99) 40 °C
Mounting on the following profiles	
Cylindrical design	 ###
Switching state	LED, Yellow
Included in delivery	1 x screw M3x20, 1 x tension bolt, 1 x spring washer

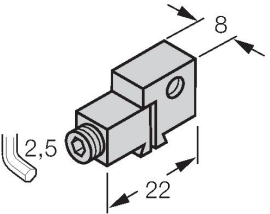
Accessories

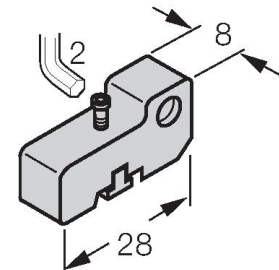
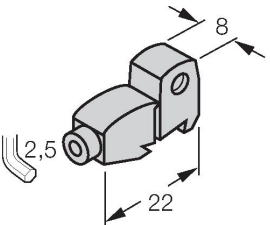
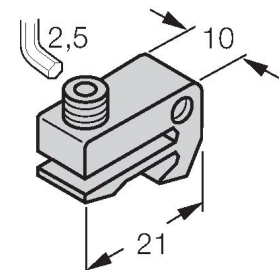
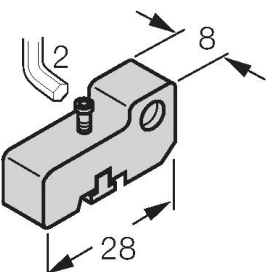
 <p>Diagram of KLN3 mounting bracket. Dimensions: 8 mm height, 22 mm length, 2.5 mm sensor diameter.</p>	<p>KLN3 6970504</p> <p>Mounting bracket for mounting magnetic field sensors on dovetail groove cylinders or  T-groove cylinders; clamping width: 5.2...13.5 mm; material: Anodized aluminum</p>	 <p>Diagram of KLN-SMC mounting bracket. Dimensions: 8 mm height, 28 mm length, 2 mm clamping width.</p>	<p>KLN-SMC 6970503</p> <p>Mounting bracket for mounting magnetic field sensors on SMC cylinders; clamping width 4 mm; material: Anodized aluminum</p>
 <p>Diagram of KLF1 mounting bracket. Dimensions: 8 mm height, 22 mm length, 2.5 mm sensor diameter.</p>	<p>KLF1 6970401</p> <p>Mounting bracket for mounting magnetic field sensors on profile cylinders with external dovetail guide; for all cylinder diameters, material: Anodized aluminum</p>	 <p>Diagram of KLF2 mounting bracket. Dimensions: 10 mm height, 21 mm length, 2.5 mm sensor diameter.</p>	<p>KLF2 6970402</p> <p>Mounting bracket for mounting magnetic field sensors on profile cylinders (IMI Norgren); cylinder diameter: 32...100 mm; material: Anodized aluminum</p>
 <p>Diagram of SMC-325 mounting bracket. Dimensions: 8 mm height, 28 mm length, 2 mm clamping width.</p>	<p>SMC-325 A3106</p> <p>Mounting bracket for mounting magnetic field sensors on SMC cylinders; clamping width 4 mm; material: Anodized aluminum</p>		

Accessories

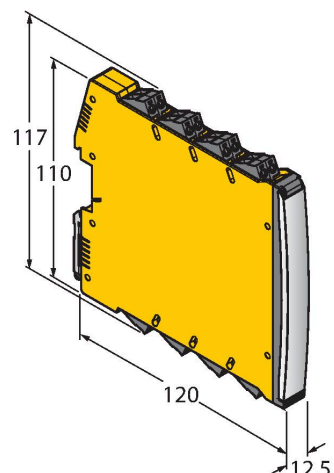
Dimension drawing	Type	ID	
	IMX12-DI01-2S-2T-0/24VDC	7580020	<p>Isolating switching amplifier, 2-channel; SIL2 acc. to IEC 61508; Ex-proof version; 2 transistor outputs; input Namur signal; ON/OFF switchable monitoring of wire-break and short-circuit; toggle between NO/NC mode; signal doubling; removable screw terminals; 12.5 mm wide; 24 VDC power supply</p>

Instructions for use

Intended use	This device fulfills Directive 2014/34/EC and is suited for use in areas exposed to explosion hazards according to EN 60079-0:2018 and EN 60079-11:2012. Further it is suited for use in safety-related systems, including SIL2 as per IEC 61508. In order to ensure correct operation to the intended purpose it is required to observe the national regulations and directives.
For use in explosion hazardous areas conform to classification	II 2 G and II 1 D (Group II, Category 2 G, electrical equipment for gaseous atmospheres and category 1 D, electrical equipment for dust atmospheres).
Marking (see device or technical data sheet)	Ex II 2 G and Ex ia IIC T6 Gb and Ex II 1 D Ex ia IIIC T135 °C Da acc. to EN 60079-0, -11
Local admissible ambient temperature	-25...+70 °C
Installation/Commissioning	<p>These devices may only be installed, connected and operated by trained and qualified staff. Qualified staff must have knowledge of protection classes, directives and regulations concerning electrical equipment designed for use in explosion hazardous areas. Please verify that the classification and the marking on the device comply with the actual application conditions.</p> <p>This device is only suited for connection to approved Exi circuits according to EN 60079-0 and EN 60079-11. Please observe the maximum admissible electrical values. After connection to other circuits the sensor may no longer be used in Exi installations. When interconnected to (associated) electrical equipment, it is required to perform the "Proof of intrinsic safety" (EN60079-14). Attention! When used in safety systems, all content of the security manual must be observed.</p>
Installation and mounting instructions	Avoid static charging of cables and plastic devices. Please only clean the device with a damp cloth. Do not install the device in a dust flow and avoid build-up of dust deposits on the device. If the devices and the cable could be subject to mechanical damage, they must be protected accordingly. They must also be shielded against strong electro-magnetic fields. The pin configuration and the electrical specifications can be taken from the device marking or the technical data sheet.
Service/Maintenance	Repairs are not possible. The approval expires if the device is repaired or modified by a person other than the manufacturer. The most important data from the approval are listed.