

Actuator and Sensor Cable, PUR Quick-turn Connection Cable RSC4Q-5/TXL

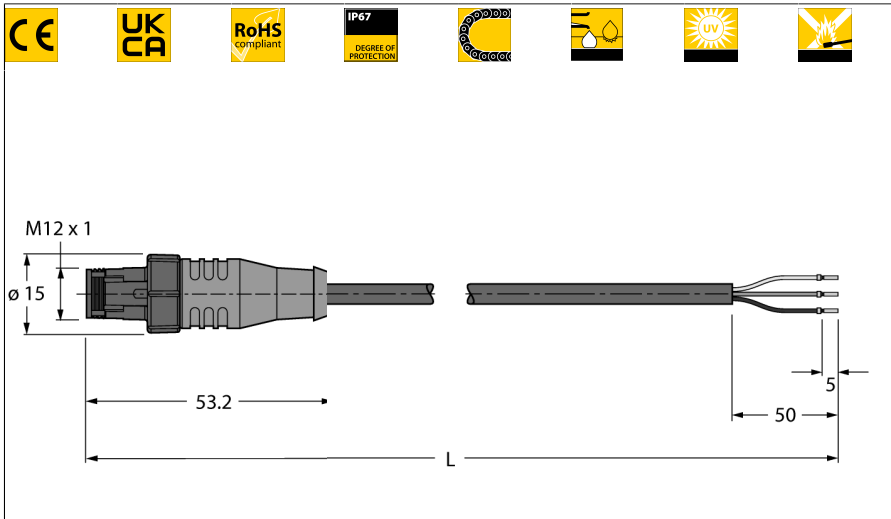

- Male M12, straight, 3-pin
- Sheath material: PUR
- Sheath color: black
- Qualified for drag chain use
- Resistant to weld splatter
- Resistant to chemicals, UV radiation and oils
- Flame retardant
- Free from halogen, silicone, PVC and LABS
- Particularly resistant to abrasion
- RoHS conform
- Protection class IP67
- Cable length: 5.0 m

Type	RSC4Q-5/TXL
ID	6628017

Connector A	Male, M12 × 1, Straight, A-coded
Number of Pins	3
Contact carriers	Plastic, TPU, Black
Connector body	Plastic, TPU, Yellow
Interlocking sleeve	Plastic, PBT, black
Mechanical lifespan	> 50 Mating cycles
Pollution degree	3
Protection class	IP67, (plugged)

Cable	
Cable diameter	Ø 4.1mm ±0.20
Cable length	5 m m
Cable jacket	PUR, Black
Core insulation	PP
Core cross-section	3 x 0.34 mm ²
Arrangement of strands	42 x 0.1mm
Core colors	BN, BU, BK

Electrical properties at +20 °C	
Rated voltage	250V
Test voltage	2000 V
Current	4AA
Insulation resistance	> 30.5 MΩ/km
forward resistance	max. 57 Ω/km

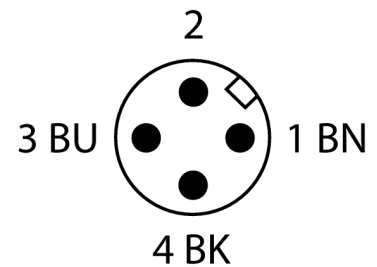

Circuit Diagram

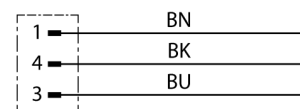

Mechanical and chemical properties	
Bending radius (stationary installation)	$\geq 5 \times \varnothing$
Bending radius (flexible use)	$\geq 10 \times \varnothing$
Bending cycles	≥ 5 million
Admissible acceleration	max. 5 m/s ²
Admissible travel path, horizontal	5 m (at 5 m/s ²)
Admissible travel path, vertical	2 m (at 5 m/s ²)
Admissible traversing speed	3.3 m/s
Torsional stress	$\pm 180^\circ/\text{m}$
Ambient temperature range (stationary)	-50...+80°C
Ambient temperature range (In motion)	-25...+80°C
Ambient temperature during drag chain operation	-25...+60°C

Accessories

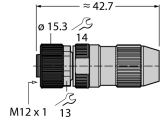
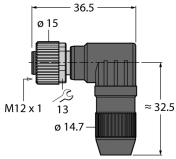
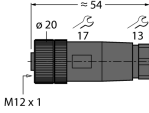
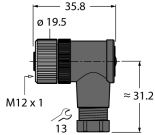
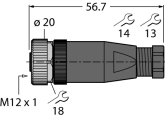
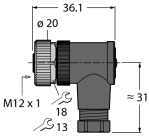
Type code	Ident no.		Dimension drawing
HA8141-0	6905407	Field-wireable female connector, M12 × 1, straight, 4-pin, insulation piercing connection, cable feedthrough 4.0 to 5.1 mm, core cross-section/terminal capacity 0.14 to 0.34 mm ² , plastic housing, metal nut	 <p>Technical drawing of a straight, 4-pin field-wireable female connector. Dimensions include a total length of approximately 42.7 mm, a diameter of 15.3 mm, and a terminal pitch of 14 mm. The connector is labeled M12 x 1 with a terminal pitch of 13 mm.</p>
HA8241-0	6905401	Field-wireable female connector, M12 × 1, angled, 4-pin, insulation piercing connection, cable feedthrough 4.0 to 5.1 mm, core cross-section/terminal capacity 0.14 to 0.34 mm ² , plastic housing, metal nut	 <p>Technical drawing of an angled, 4-pin field-wireable female connector. Dimensions include a total length of 36.5 mm, a diameter of 15 mm, and a terminal pitch of 13 mm. The angled section has a diameter of 14.7 mm. The connector is labeled M12 x 1 with a terminal pitch of 13 mm.</p>
B8141-0	69049	Field-wireable female connector, M12 × 1, straight, 4-pin, screw terminal connection, cable feedthrough 4.0 to 6.0 mm, core cross-section/terminal capacity 0.14 to 0.75 mm ² , plastic housing, plastic nut	 <p>Technical drawing of a straight, 4-pin field-wireable female connector with screw terminals. Dimensions include a total length of 54 mm, a diameter of 20 mm, and a terminal pitch of 17 mm. The connector is labeled M12 x 1 with a terminal pitch of 13 mm.</p>
B8241-0	69048	Field-wireable female connector, M12 × 1, angled, 4-pin, screw terminal connection, cable feedthrough 4.0 to 6.0 mm, core cross-section/terminal capacity 0.14 to 0.75 mm ² , plastic housing, plastic nut	 <p>Technical drawing of an angled, 4-pin field-wireable female connector with screw terminals. Dimensions include a total length of 35.8 mm, a diameter of 19.5 mm, and a terminal pitch of 13 mm. The connector is labeled M12 x 1 with a terminal pitch of 13 mm.</p>
BM8141-0	6935145	Field-wireable female connector, M12 × 1, straight, 4-pin, screw terminal connection, cable feedthrough 4.0 to 6.0 mm, core cross-section/terminal capacity 0.25 to 0.75 mm ² , plastic housing, metal nut	 <p>Technical drawing of a straight, 4-pin field-wireable female connector with screw terminals. Dimensions include a total length of 56.7 mm, a diameter of 20 mm, and a terminal pitch of 14 mm. The connector is labeled M12 x 1 with a terminal pitch of 18 mm.</p>
BM8241-0	6935889	Field-wireable female connector, M12 × 1, angled, 4-pin, screw terminal connection, cable feedthrough 4.0 to 6.0 mm, core cross-section/terminal capacity 0.25 to 0.75 mm ² , plastic housing, metal nut	 <p>Technical drawing of an angled, 4-pin field-wireable female connector with screw terminals. Dimensions include a total length of 36.1 mm, a diameter of 20 mm, and a terminal pitch of 13 mm. The connector is labeled M12 x 1 with a terminal pitch of 18 mm.</p>

Accessories

Type code	Ident no.		Dimension drawing
BLANK-LABEL-FOR-CORDESETS-TEL-TXL	6936206	Label for TEL and TXL cables, length: 18 mm, height: 4 mm, material: polycarbonate (PC), color: white, halogen-free and flame-retardant	