

# BC5-S18-AP4X-H1141/S250

## Capacitive Sensor

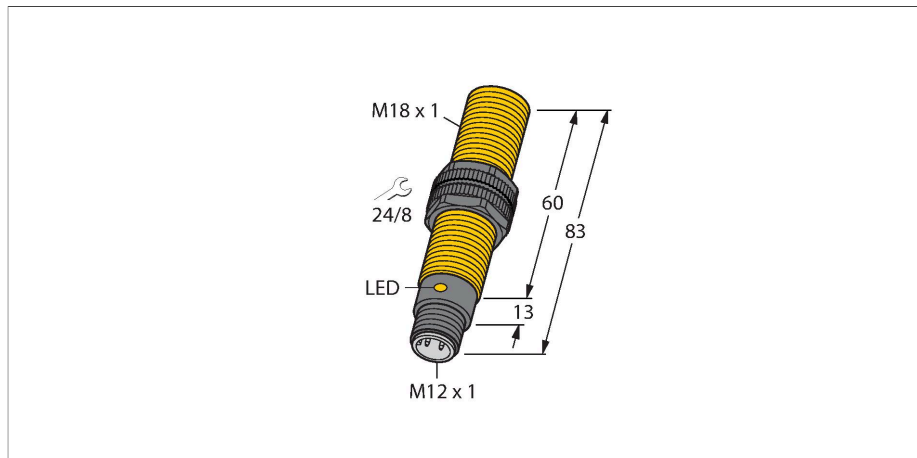

### Features

- M18 × 1 threaded barrel
- Plastic, PA12-GF30
- Fixed settings
- DC 3-wire, 10...65 VDC
- NO contact, PNP output
- M12 × 1 connector

### Wiring diagram

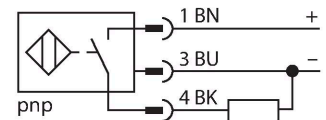

### Technical data

Type	BC5-S18-AP4X-H1141/S250
ID	2503602
Rated switching distance (flush)	5 mm
Rated switching distance (non-flush)	5 mm
Secured operating distance	$\leq (0.72 \times S_n)$
Hysteresis	1...20 %
Temperature drift	Typical 20 %
Repeat accuracy	$\leq 2$ % of full scale
Ambient temperature	-25...+70 °C
<b>Electrical data</b>	
Operating voltage	65 VDC
Residual ripple	$\leq 10$ % $U_{ss}$
DC rated operational current	$\leq 200$ mA
No-load current	$\leq 15$ mA
Residual current	$\leq 0.1$ mA
Switching frequency	0.1 kHz
Oscillation frequency	According to EN 60947-5-2, 8.2.6.2 Table 9: 0.1...2.0 MHz
Isolation test voltage	$\leq 0.5$ kV
Output function	3-wire, NO contact, PNP
Short-circuit protection	yes / Cyclic
Voltage drop at $I_o$	$\leq 1.8$ V
Wire breakage/Reverse polarity protection	yes / Complete
<b>Tests/approvals</b>	
Approvals	UL
UL registration number	E210608

### Functional principle

Capacitive proximity switches are designed for contactless and wear-free detection of electrically conductive as well as non-conductive metal objects.

Flush mounting may result in a change of switching behaviour.

## Technical data

Mechanical data	
Design	Threaded barrel, M18 x 1
Dimensions	83 mm
Housing material	Plastic, PA12-GF30, PEI
Active area material	PA12-GF30, yellow
Admissible pressure on front cap	≤ 6 bar
Max. tightening torque of housing nut	2 Nm
Electrical connection	Connector, M12 × 1
Vibration resistance	55 Hz (1 mm)
Shock resistance	30 g (11 ms)
Protection class	IP67
MTTF	1080 years acc. to SN 29500 (Ed. 99) 40 °C
Power-on indication	Green
Switching state	LED, Yellow

## Mounting instructions

### Product features

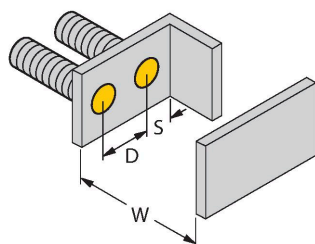
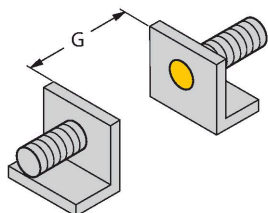

Distance D	36 mm
Distance W	15 mm
Distance S	27 mm
Distance G	30 mm
Diameter active area B	Ø 18 mm

The given minimum distances have been checked against the standard switching distance.

Should the sensitivity of the sensors be changed via potentiometer, the data sheet specifications no longer apply.

## Accessories

### BS 18 69471

Mounting clamp for threaded barrel sensors; material: PA66-GF

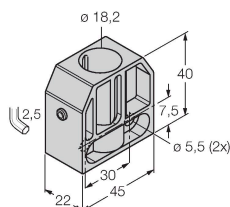

### BSN 18 69472

Mounting clamp for threaded barrel sensors; material: PA66-GF

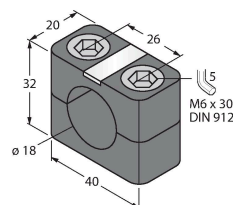

BST-18B

6947214

Mounting clamp for threaded barrel sensors, with dead-stop; material: PA6

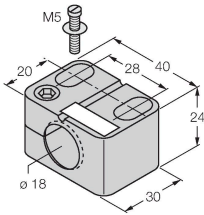

MAP-M18

6950012

Mounting adapter; material: Polypropylene; sensor replacement with filled container possible (adapter remains in container during sensor replacement)

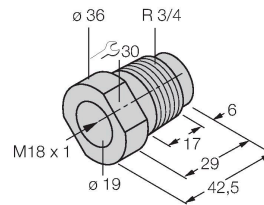

## Accessories

Dimension drawing	Type	ID	
	RKC4.4T-2/TXL	6625503	Connection cable, M12 female connector, straight, 4-pin, cable length: 2 m, jacket material: PUR, black; cULus approval
	WKC4.4T-2/TXL	6625515	Connection cable, M12 female connector, angled, 4-pin, cable length: 2 m, jacket material: PUR, black; cULus approval
	WKC4.4T-2/TEL	6625025	Connection cable, M12 female connector, angled, 4-pin, cable length: 2 m, jacket material: PVC, black; cULus approval
	RKC4.4T-2/TEL	6625013	Connection cable, M12 female connector, straight, 4-pin, cable length: 2 m, jacket material: PVC, black; cULus approval
	RKC4.4T-P7X2-10/TXL	6626184	Connection cable, M12 female connector, straight, 4-pin, LED, cable length: 10 m, jacket material: PUR, black; cULus approval
	RKC4.4T-2-RSC4.4T/TEL	6625208	Extension cable, M12 female connector, straight, 4-pin to M12 male connector, straight, 4-pin, cable length: 2 m, jacket material: PVC, black; cULus approval

Dimension drawing	Type	ID	
	RKC4.4T-2-RSC4.4T/TXL	6625608	Extension cable, M12 female connector, straight, 4-pin to M12 male connector, straight, 4-pin; cable length: 2 m, jacket material: PUR, black; cULus approval
	RKC4.4T-2-WSC4.4T/TXL	6625624	Extension cable, M12 female connector, straight, 4-pin to M12 male connector, angled, 4-pin; cable length: 2 m, jacket material: PUR, black; cULus approval
	WKC4.4T-2-WSC4.4T/TXL	6625656	Extension cable, M12 female connector, angled, 4-pin to M12 male connector, angled, 4-pin; cable length: 2 m, jacket material: PUR, black; cULus approval