

RI360P0-QR24M0-HESG25X3-H1181

Contactless Encoder – SSI

Premium Line

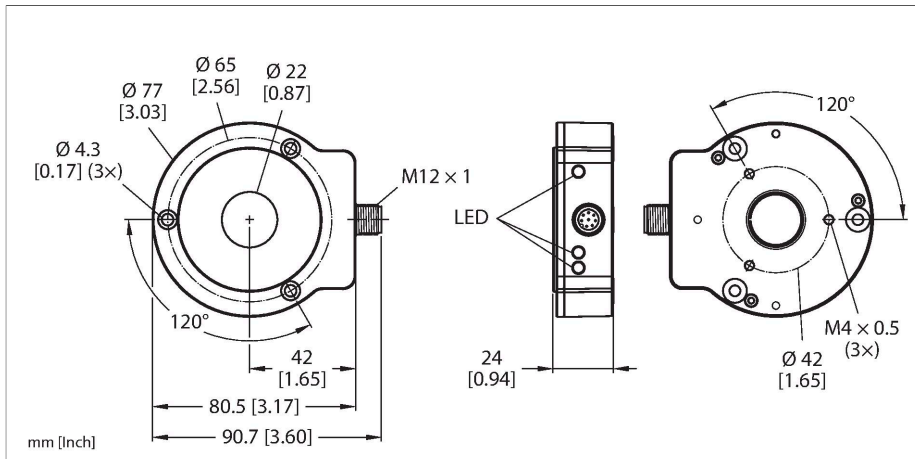

Technical data

Type	RI360P0-QR24M0-HESG25X3-H1181
ID	1590905
Measuring principle	Inductive
General data	
Max. Rotational Speed	6000 rpm
Starting torque shaft load (radial / axial)	Determined with standardized construction, with a steel shaft Ø 20 mm, L = 50 mm and reducer Ø 20 mm not applicable, because of contactless measuring principle
Measuring range	0...360 °
Nominal distance	1.5 mm
Repeat accuracy	≤ 0.01 % of full scale
Linearity deviation	≤ 0.05 % f.s.
Temperature drift	≤ ± 0.003 %/K
Output type	Absolute semi-multiturn
Resolution singleturn	16 bit/65,536 units per revolution
Resolution multiturn	6 bit/64 revolutions
Number of diagnostic bits	3 Bit
Electrical data	
Operating voltage	15...30 VDC
Residual ripple	≤ 10 % U _{ss}
Isolation test voltage	≤ 0.5 kV
Wire breakage/Reverse polarity protection	yes (voltage supply)
Communication protocol	SSI
Output function	8-pin, 25 Bit, Gray coded

Features

- Compact, rugged housing
- Many mounting possibilities
- Status displayed via LED
- Positioning element and aluminium ring not incl.
- SSI output
- 25 bit, Gray-coded
- SSI clock rate: 62.5 KHz ... 1 MHz
- Single or multiturn, length of data frame and bit coding parametrizable via PACTware with programming box USB-2-IOL-0002 and adapter cable RKC8.302T-1,5-RSC4T/TX320
- Default settings: Singleturn Bit 0 ... Bit 15, Multiturn Bit 16 ... Bit 21, Status Bit 22 ... Bit 24
- Zero point, sync./async. operating mode adjustable via Easy Teach
- Compatible with all standard SSI masters
- In sync. mode, jitter < 5 µs required on the master side
- Immune to electromagnetic interference
- 15...30 VDC
- Male M12 x 1, 8-pin

Wiring diagram

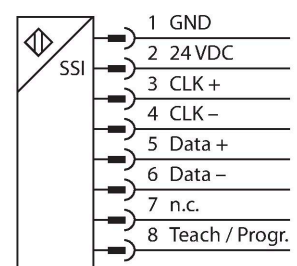

Technical data

Process data area	configurable
Diagnostic bits	<p>Bit 22: Position was changed during power drop</p> <p>Bit 23: Positioning element has reached the end of the measuring range. This is indicated by a lower signal quality.</p> <p>Bit 24: Positioning element is outside the measuring range.</p>
	Data messages parametrizable as multi-turn and singleturn process data or error bits
Sample rate	5000 Hz
	The sensor's sampling rate depends on the master's SSI cycle time. Sampling rate 1...5 KHz in synchronized operating mode (signal propagation delay 200 µs)
Current consumption	< 100 mA
Mechanical data	
Design	QR24
Dimensions	81 x 78 x 24 mm
Flange type	Flange without mounting element
Shaft Type	Hollow shaft
Shaft diameter D [mm]	<p>6</p> <p>6.35</p> <p>9.525</p> <p>10</p> <p>12</p> <p>12.7</p> <p>14</p> <p>15.875</p> <p>19.05</p> <p>20</p>
Housing material	Metal/plastic, ZnAlCu1/PBT-GF30-V0
Electrical connection	Connector, M12 × 1
Environmental conditions	
Ambient temperature	-25...+85 °C
	Acc. to UL approval to +70 °C
Vibration resistance	55 Hz (1 mm)
Vibration resistance (EN 60068-2-6)	20 g; 10...3000 Hz; 50 cycles; 3 axes
Shock resistance (EN 60068-2-27)	100 g; 11 ms ½ sine; 3 × each; 3 axes
Continuous shock resistance (EN 60068-2-29)	40 g; 6 ms ½ sine; 4000 × each; 3 axes
Protection class	IP68 IP69K
MTTF	138 years acc. to SN 29500 (Ed. 99) 40 °C
Power-on indication	LED, Green
Measuring range display	LED, yellow, yellow flashing
Error indication	LED, red

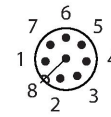

Functional principle

The measuring principle of inductive encoders is based on oscillation circuit coupling between the positioning element and the sensor, whereby an output signal is provided proportional to the angle of the positioning element. Turck refers to semi-multiturn because the multiturn process data is calculated internally from the number of single-turn zero passes. Because the sensor does not detect any revolutions when not supplied with power, the plausibility of the multiturn process data is indicated by a diagnostic bit. The rugged sensors are maintenance- and wear-free thanks to the contactless operating principle. They convince through their excellent repeatability, resolution and linearity within a broad temperature range. The innovative technology ensures high immunity to electromagnetic DC and AC fields.

Technical data

Included in delivery

MT-QR24 mounting aid

Mounting instructions

Mounting instructions/Description

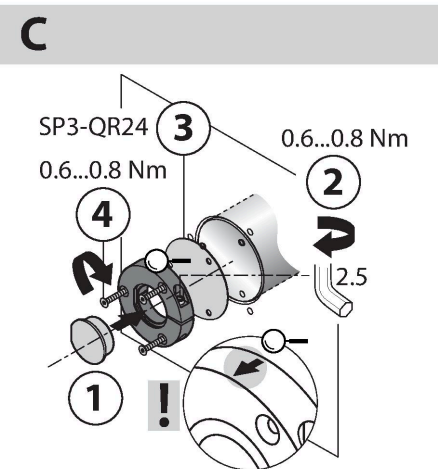
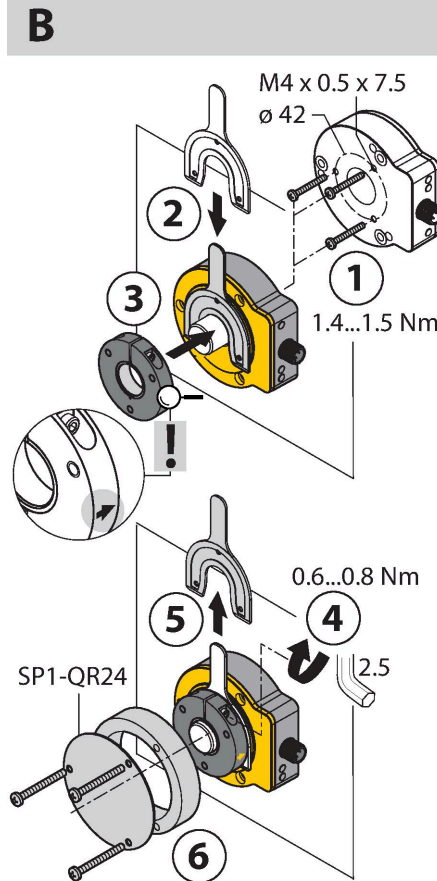
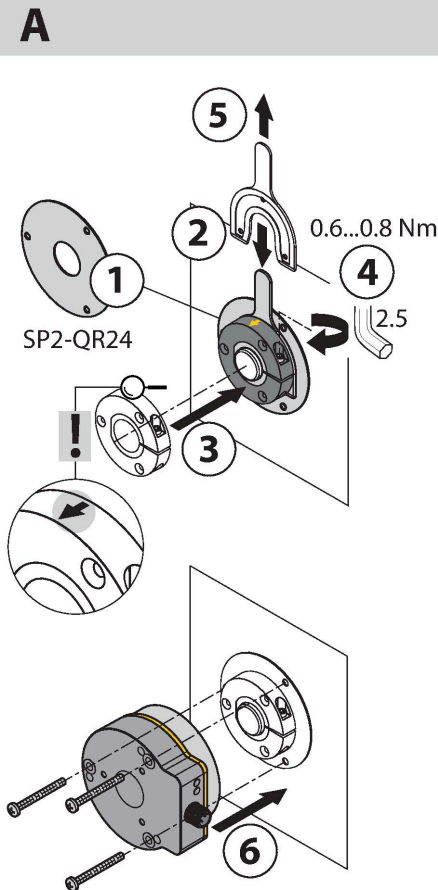

Default: 0°

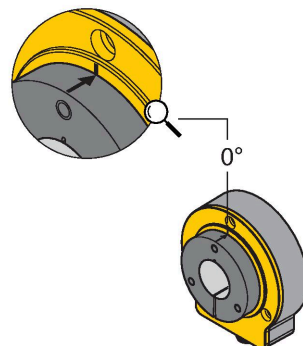

Extensive range of mounting accessories for easy adaptation to many different shaft diameters. Based on the functional principle of RLC coupling, the encoder is immune to magnetized metal splinters and other interferences.

The adjacent figure shows the two separate units, sensor and positioning element.

Mounting option A:

First, interconnect positioning element and rotatable shaft with the bracket. Then place the encoder above the rotating part in such a way that you get a tight and protected unit.

Mounting option B:

Push the encoder on the back site of the shaft and fasten it to the machine. Then clamp the positioning element to the shaft with the bracket.

Mounting option C:

If the positioning element is screwed on a rotating machine part and not to a shaft, you must first put on the dummy plug RA8-QR24. Then tie up the bracket. Screw on the encoder via the three bores.

When mounting, ensure that the positioning element is correctly aligned towards the sensor's active face. For correct fitting see arrow on the edge of the positioning element. (Arrow must point in direction of sensor)

Due to the separate installation of positioning element and sensor no electrical currents or harmful mechanical forces are transmitted via the shaft to the sensor. The encoder also offers a high degree of protection for life and stays permanently sealed.

The accessories enclosed in the delivery help to mount encoder and positioning element at an optimal distance from each other. LEDs indicate the switching status. Optionally, you can use the shield plates which are included in the accessories to increase the allowed distance between positioning element and sensor.

Status display via LED

green

Sensor is supplied correctly, asynchronous mode

green flashing

Sensor is supplied properly, synchronous mode

green fast flashing:

Sensor is supplied properly but is not receiving CLK pulses from the SSI master

yellow

Positioning element is in the measuring range, signal low (e.g. distance too large), see status bit 23

yellow flashing

Positioning element is outside the coverage, see status bit 24

off

Positioning element is in the measuring range

Multiturn error
red:
Position was changed during power drop, see
status bit 22

Parameters	Easy-Teach Input	LED Display	Description
Zero point	Bridge Pin 1 (GND) and Pin 8 for 2 s	Status LED flashes, after 2 s steady	Encoder position set to zero. The Multiturn flag and the red LED are reset
Switching between sync/async mode	Bridge Pin 2 (U _B) and Pin 8 for 2 s	Status LED flashes, after 2 s steady Power LED steady green: async mode, Power LED flashes green: sync mode	The encoder is by default set to asynchronous mode. The encoder switches between async/ sync mode by means of a teach pulse
Effective mode	Bridge Pin 2 (U _B) and Pin 8 for 10 s	After 10 s status LED flashes for 2 s	Effective direction of encoder CW (factory setting) Multiturn values are reset
	Bridge Pin 1 (GND) and Pin 8 for 10 s	After 10 s status LED flashes for 2 s	Effective direction of encoder CCW Multiturn values are reset
Multiturn error- flag	Bridge Pin 1 (GND) and Pin 8 for 15 s	After 15 s power and status LED alterante	Multiturn Error and multiturn counters are reset
Switching between single/multiturn mode	Bridge Pin 2 (U _B) and Pin 8 for 20 s	After 20 s the red LED flashes	Validity depends on revision status
Easy-Teach reset	Bridge Pin 2 (U _B) and Pin 8 for 15 s	After 15 seconds, power and status LED flash alternately; In case the red LED lights up, the Easy-Teach reset must be triggered again	The following factory defaults are restored: Effective direction (CW), zero point, multiturn error (delete), multiturn counter (zero)

To avoid unintended teaching, keep pin 8 potential-free.

Accessories

P1-RI-QR24 	1590921 Positioning element, for Ø 20 mm shafts	P2-RI-QR24 	1590922 Positioning element, for Ø 14 mm shafts
P3-RI-QR24 	1590923 Positioning element, for Ø 12 mm shafts	P4-RI-QR24 	1590924 Positioning element, for Ø 10 mm shafts
P5-RI-QR24 	1590925 Positioning element, for Ø 6 mm shafts	P6-RI-QR24 	1590926 Positioning element, for Ø 3/8" shafts

P7-RI-QR24 1590927

Positioning element, for Ø 1/4" shafts

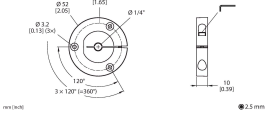

P9-RI-QR24 1593012

Positioning element for installation on Ø 1/2" shafts

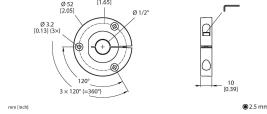

P10-RI-QR24 1593013

Positioning element for installation on Ø 5/8" shafts

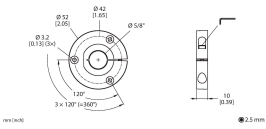

P11-RI-QR24 1593014

Positioning element for installation on Ø 3/4" shafts

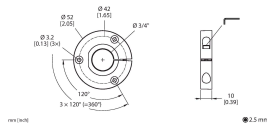

P8-RI-QR24 1590916

Positioning element with blanking plug for large shafts

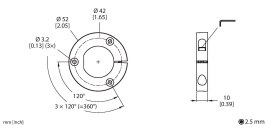

M1-QR24 1590920

Aluminum protecting ring, for inductive encoders RI-QR24

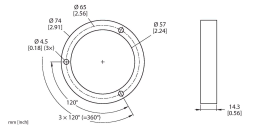

PE1-QR24 1590937

Positioning element without adapter sleeve

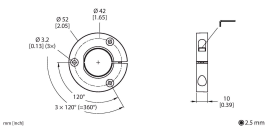

RA1-QR24 1590928

Adapter sleeve, for Ø 20 mm shafts

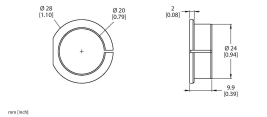

RA2-QR24 1590929

Adapter sleeve, for Ø 14 mm shafts

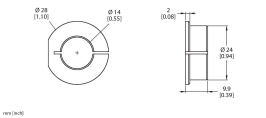

RA3-QR24 1590930

Adapter sleeve, for Ø 12 mm shafts

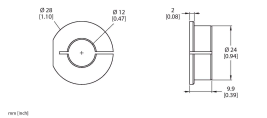

RA4-QR24 1590931

Adapter sleeve, for Ø 10 mm shafts

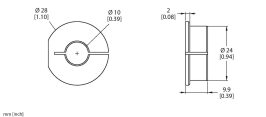

RA5-QR24 1590932

Adapter sleeve, for Ø 6 mm shafts

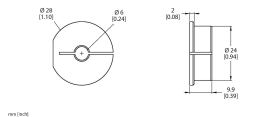

RA6-QR24 1590933

Adapter sleeve, for Ø 3/8" shafts

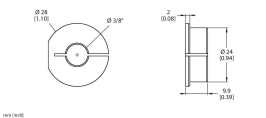

RA7-QR24 1590934

Adapter sleeve, for Ø 1/4" shafts

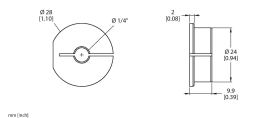

RA9-QR24 1590960

Adapter sleeve, for Ø 1/2" shafts

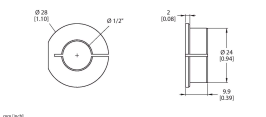

RA10-QR24 1590961

Adapter sleeve, for Ø 5/8" shafts

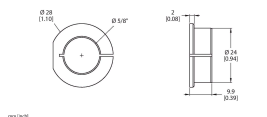

RA11-QR24 1590962

Adapter sleeve, for Ø 3/4" shafts

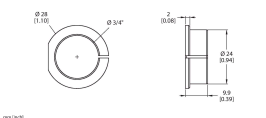

RA8-QR24 1590959

Plug for mounting option C

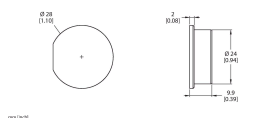

SP1-QR24 1590938

Shield plate Ø 74 mm, aluminium

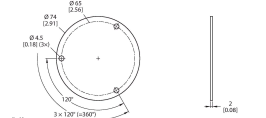

SP2-QR24 1590939

Shield plate Ø 74 mm, aluminium, with borehole for shaft feedthrough

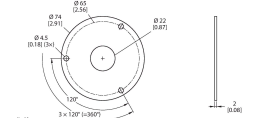

SP3-QR24

1590958

Shield plate Ø 52 mm, aluminium

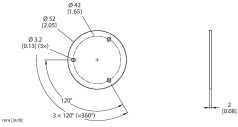

MT-QR24

1590935

Mounting aid for optimal alignment of positioning element

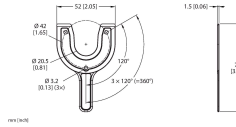

Accessories

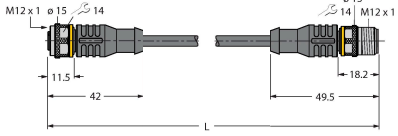
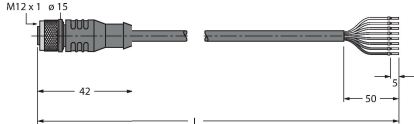
Dimension drawing	Type	ID	
	RKC8T-2/TXL	6625142	Connection cable, M12 female connector, straight, 8-pin, cable length: 2 m, jacket material: PUR, black; cULus approval
	RKC8.302T-1.5-RSC4T/TXL320	6625003	Adapter cable to connect sensor to USB-2-IOL-0002 programming unit; M12 female connector, straight, 8-pin to M12 male connector, straight, 3-pin; cable length: 1.5 m; jacket material: PUR, black; cULus approved; RoHS compliant; protection class IP67
	E-RKC 8T-264-2	U-04781	Connection cable, female M12, straight, 8-pin (twisted pairs), shielded, cable length: 2 m, sheath material: PVC, black; cULus approval; other cable lengths and qualities available, see www.turck.com

Accessories

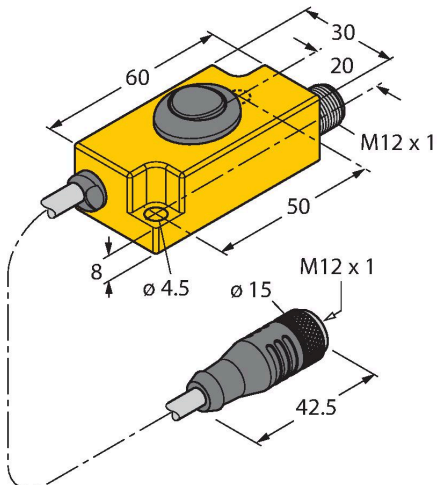
Dimension drawing	Type	ID	
	TX2-Q20L60	6967117	Teach adapter for inductive encoders with 8-pin male M12 x 1, for simple programming via Easy Teach

Dimension drawing	Type	ID	
	USB-2-IOL-0002	6825482	IO-Link Master with integrated USB port

