

S30AW3R

Photoelectric Sensor – Opposed Mode Sensor (Receiver)

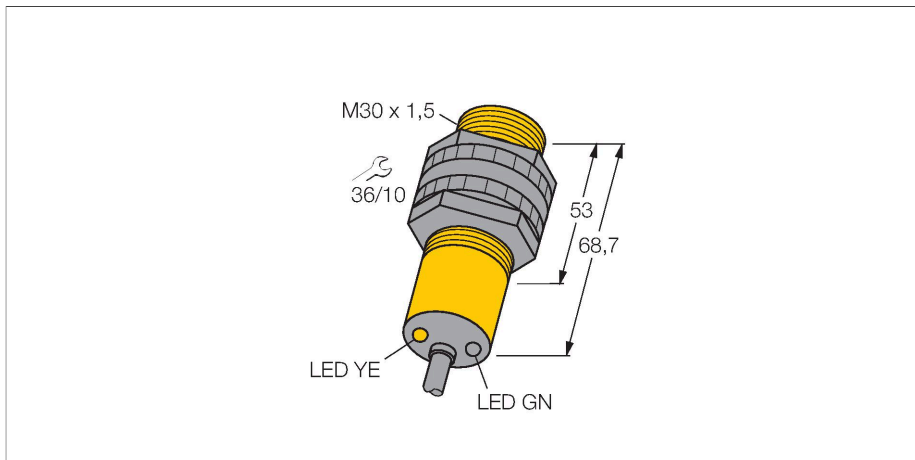

Technical data

Type	S30AW3R
ID no.	3032340
Optical data	
Function	Opposed mode sensor
Operating mode	Receiver
Range	0...60000 mm
Electrical data	
Operating voltage	20...250 VAC
AC rated operational current	≤ 200 mA
Output function	Light operation, Relay output
Switching frequency	≤ 40 Hz
Readiness delay	≤ 100 ms
Response time typical	< 16 ms
Mechanical data	
Design	Threaded barrel, S30
Dimensions	Ø 30 x 80.7 mm
Housing material	Plastic, Thermoplastic material
Lens	plastic, Acrylic
Electrical connection	Cable, 2 m, PVC
Number of cores	3
Ambient temperature	-40...+70 °C
Protection class	IP67
Special features	Encapsulated
Power-on indication	LED, Green
Switching state	LED, Yellow
Excess gain indication	LED

Features

- Cable, 2 m
- Protection class IP67
- Ambient temperature: -40...+70 °C

Wiring diagram

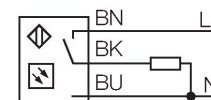

Functional principle

Opposed mode sensors consist of an emitter and receiver. They are installed opposite each other so that the light from the emitter is aimed directly at the receiver. When an object interrupts or weakens the light beam, the sensor switches. Opposed mode sensors are the most reliable photoelectric sensors for detection of opaque targets. An excellent contrast between light and dark conditions and an extremely high excess gain are typical of this sensing mode, thus allowing operation over larger distances and under difficult conditions. Excess gain curve
Excess gain in relation to the distance

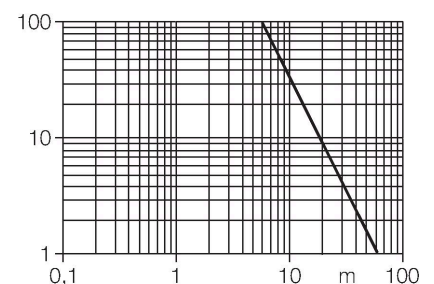

Technical data

Tests/approvals

Approvals

CE, UL, CSA

Accessories

SMB30A

3032723

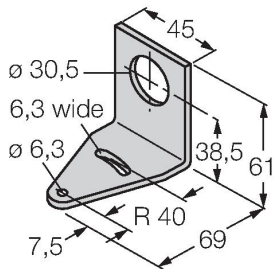

Mounting bracket, rectangular, stainless steel, for sensors with 30mm thread

SMB30FAM10

3011185

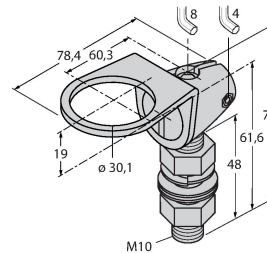

Mounting bracket, stainless steel, for M10 x 1.5 thread, thread length 30 mm

SMB30SC

3052521

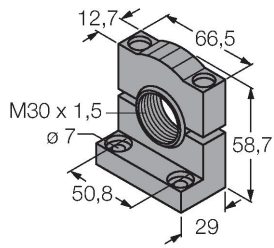

Mounting bracket, PBT black, for sensors with 30 mm thread, rotatable

SMBAMS30P

3073135

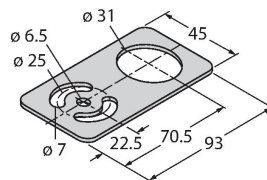

Mounting bracket, stainless steel, for sensors with 30 mm thread