

LTF12KC2LDQP

Photoelectric Sensor – Laser Scanning System

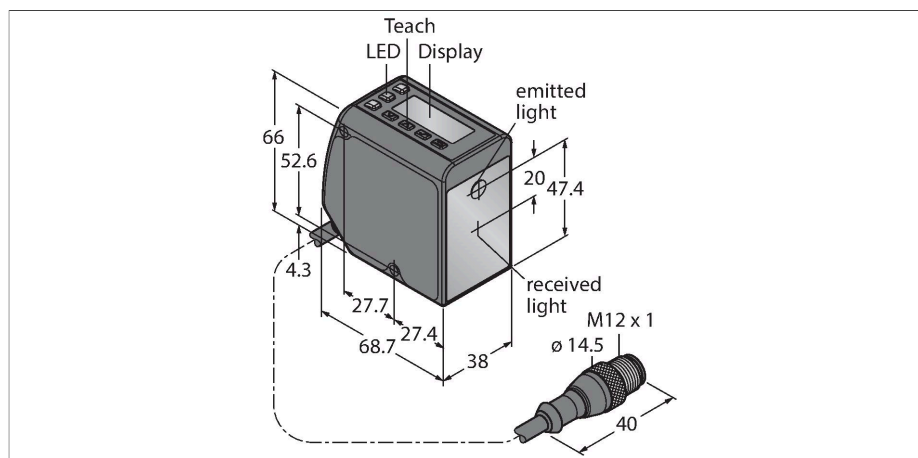

Technical data

Type	LTF12KC2LDQP
ID no.	3801131
Optical data	
Function	Proximity switch
Operating mode	Runtime
Light type	Red
Wavelength	660 nm
Laser class	▲ 2
Optical resolution	3 mm
Repeatability	1.5 mm
Range	50...12000 mm
Ambient light immunity	40000 lux
Electrical data	
Operating voltage	12...30 VDC
DC rated operational current	≤ 85 mA
Short-circuit protection	yes
Reverse polarity protection	yes
Communication protocol	IO-Link
Output function	NO/NC, PNP
Switching frequency	≤ 250 Hz
Readiness delay	≤ 2 s
Readiness delay	≤ 2000 ms
Response time typical	< 1.5 ms
IO-Link	
IO-Link specification	V 1.1
IO-Link port type	Class A
Communication mode	COM 2 (38.4 kBaud)

Features

- 2-line, 8-segment display
- Cable, PVC, 150 mm with M12 × 1 male connector, 5-pin
- Range: 0.05...12 m
- Laser class 2, red, 660 nm, acc. to IEC 60825-1:2007
- Resolution: 0.3...3 mm
- Operating voltage: 12...30 VDC
- Output 1: PNP switching output with IO-Link communication
- Output 2: PNP switching output, alarm output or pulse frequency modulation (PFM)
- Transmission of process value and parametrization via IO-link

Wiring diagram

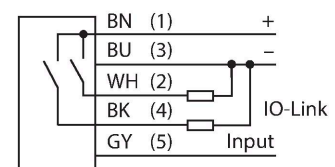

Functional principle

The LTF laser sensors measure the distance to an object up to a range of 12 m. The settings are made via buttons on the housing. The built-in display assists with the menu navigation and serves to display the measured distance. The switching output is re-programmable and the analog output is, depending on the type, either laid out as current or voltage output. The integrated connector is rotatable by 90° degrees which makes it easy to mount. The transmitter LED can be turned off via the menu or the gray wire (PIN 5). The same wire can be used to operate two devices in the synch mode, which prevents mutual influence. The measuring accuracy can be obtained from the excess gain curve.

Technical data

Process data width	16 bit
Frame type	Type_2_2
Minimum cycle time	2 ms
Function Pin 4	IO-Link
Function Pin 2	DI
Maximum cable length	20 m
Profile support	Smart Sensor Profil
Included in the SIDI GSDML	Yes
Mechanical data	
Design	Rectangular, LTF
Dimensions	77 x 26 x 56 mm
Housing material	Metal, Die-cast zinc alloy, Black
Lens	plastic, Polycarbonate
Electrical connection	Cable with connector, M12 × 1, 0.15 m, PVC
Number of cores	5
Ambient temperature	-20...+55 °C
Storage temperature	-30...+65 °C
Relative humidity	90 %
Protection class	IP67
Special features	Pump function keep/defer
Power-on indication	LED, Green
Switching state	LED, Yellow
Tests/approvals	
Vibration resistance	acc. to IEC 60947-5-2
Shock test	acc. to IEC 60947-5-2
Approvals	CE

Excess Gain Curve

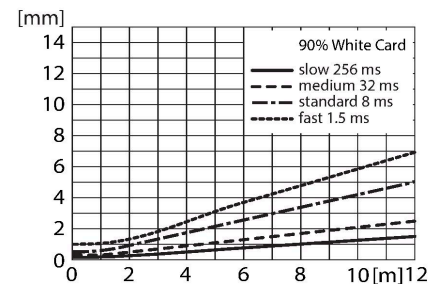

Accessories

SMBLTFU

3094757

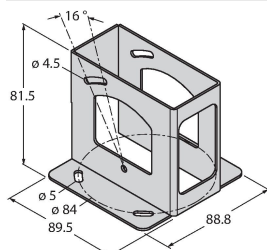

Protective housing, stainless steel, for sensors of the LTF series

SMBLTFL

3094756

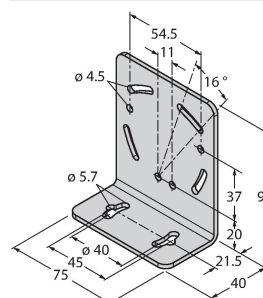

Mounting bracket, rectangular, stainless steel, for sensors of the LTF series

Accessories

Dimension drawing	Type	ID no.	
	RKC4.5T-2/TEL	6625016	Connection cable, female M12, straight, 5-pin, cable length: 2 m, sheath material: PVC, black; cULus approval; other cable lengths and qualities available, see www.turck.com
	WKC4.5T-2/TEL	6625028	Connection cable, female M12, angled, 5-pin, cable length: 2 m, sheath material: PVC, black; cULus approval; other cable lengths and qualities available, see www.turck.com

Accessories

Dimension drawing	Type	ID no.	
	BL67-4IOL	6827386	4-channel IO-Link Master module for the modular BL67 I/O-system
	BL20-E-4IOL	6827385	IO-Link master module for the modular BL20 I/O system, 4-channel

Dimension drawing	Type	ID no.	
	USB-2-IOL-0002	6825482	IO-Link Master with integrated USB port

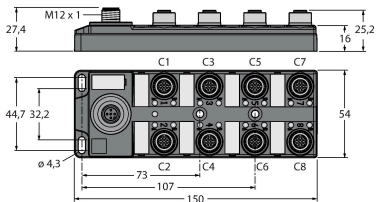
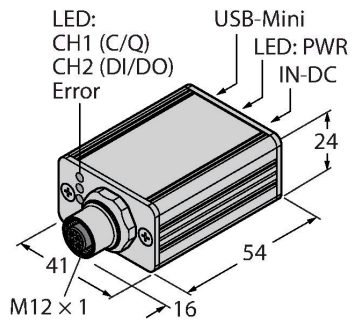

TBIL-M1-16DXP

6814102

16-channel I/O-hub for the connection of 16 digital PNP signals to an IO-Link master (input/output freely selectable per channel)

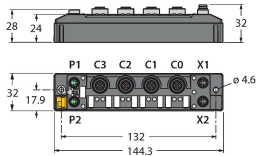

TBEN-S2-4IOL

6814024

Compact multiprotocol I/O module, 4 IO-Link Master 1.1 Class A, 4 universal PNP digital channels 0.5 A