

AIDA-GC-AIDA-GC-4416-5M

Industrial Ethernet Cable, PUR – Power cable according to AIDA

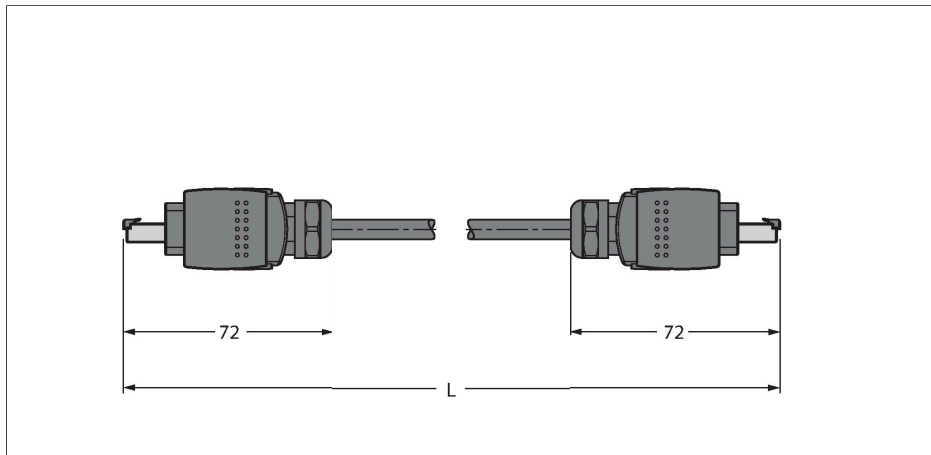

Features



- RJ45 connector acc. to IEC 60603-7
- Ethernet cable: 4-pin, AWG 22
- CAT 5E
- Jacket material: PUR
- Jacket color: green
- Shield: Aluminum foil overlapped, tinned copper wire
- Jacket diameter: 6.5 mm
- Oil resistant acc. to IEC 60811-2-1 and UL13
- Free from halogen acc. to IEC 60754
- Flame-retardant acc. to IEC 60332-1-2 and UL2556 VW1
- RoHS-compliant
- AIDA-compliant
- Protection class: IP65 and IP67

Cable Cross-Section

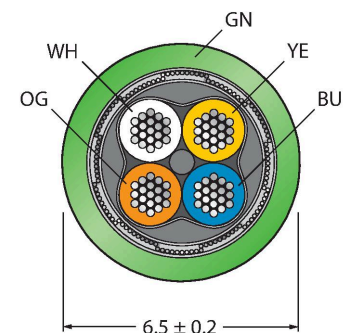

Contact assignment



Technical data

Type	AIDA-GC-AIDA-GC-4416-5M
ID	6935651
Connector A	Male, RJ45, Straight
Number of Pins	4
Contacts	Metal, CuZn, Gold-plated
Contact carriers	Plastic, Black
Connector body	Die-cast Zinc, GD-Zn, Nickel-plated, silver-plated
Mechanical lifespan	> 750 Mating cycles
Protection class	IP65, IP67, (plugged)
Connector B	Male, RJ45, Straight
Number of pins	4
Contacts	Metal, CuZn, Gold-plated
Contact carriers	Plastic, Black
Connector body	Die-cast Zinc, GD-Zn, nickel-plated
Mechanical life	> 750 Mating cycles
Protection class	IP65, IP67, (Plugged)
Cable	
Network protocol	Ethernet
Cable diameter	Ø 6.5 mm ±0.20
Cable jacket	PUR, Green
Shielding	Aluminum foil, tinned copper wire
Core insulation	PE
Core cross-section	4 x 0.32 mm ²
Arrangement of strands	7 x 0.25 mm
Core colors	WH, YE, BU, OG

Technical data

Electrical properties at +20 °C	
Rated voltage	40 V
Test voltage	2000 V
Current	3 A
DC resistance (loop)	120 Ω/km
Nom. impedance	100 Ω (1MHZ)
Nom. capacitance	50 pF/m
Mechanical and chemical properties	
Bending radius (stationary installation)	≥ 5 x Ø
Bending radius (flexible use)	≥ 8 x Ø
Bending cycles	≥ 3 million
Torsional stress	± 180 °/m
Torsion cycles	≤ 100,000 Cycles
Ambient temperature range (stationary)	-40...+70 °C
Ambient temperature range (In motion)	-20...+60 °C
Other Features	
Qualified for drag chain use	yes
Halogen-free	yes
PVC-free	yes
UV resistance	yes
Oil-resistant	yes
Flame-retardant	yes
Approvals	UL Listed

Circuit Diagram

