

RKM43-10-RSM43

Power Supply Cable, PUR – Extension Cable

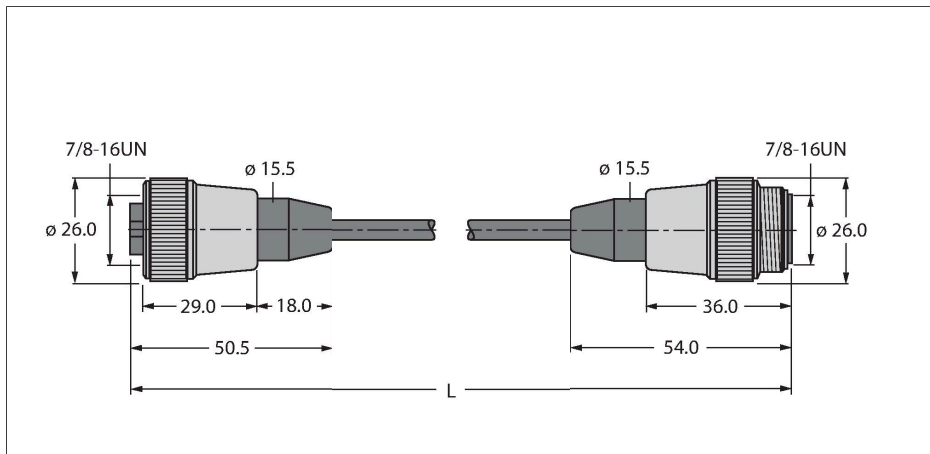

Features



- Power cable: $4 \times 1.5 \text{ mm}^2$
- Jacket material: PUR, color: gray
- Jacket diameter: 7.5 mm
- Suitable for drag chain use
- Oil resistant and flame retardant
- Halogen free
- 7/8" male, straight
- 7/8" female, straight
- Cable length: 10 m

Technical data

Type	RKM43-10-RSM43
ID	6914316
Connector A	Female, 7/8"-16 UN, Straight
Number of Pins	4
Contacts	Metal, CuZn, Gold-plated
Contact carriers	Plastic, TPU, Black
Connector body	Plastic, TPU, Black
Coupling nut/screw	Brass, CuZn, Nickel-plated
Mechanical lifespan	> 100 Mating cycles
Pollution degree	3
Protection class	IP67, Only in screwed condition
Connector B	Male, 7/8"-16 UN, Straight
Number of pins	4
Contacts	Metal, CuZn, Gold-plated
Contact carriers	Plastic, TPU, Black
Connector body	Plastic, TPU, Black
Coupling nut/retaining screw	Brass, CuZn, Nickel-plated
Mechanical life	> 100 Mating cycles
Pollution degree	3
Protection class	IP67, Only when screwed together
Cable	
Network protocol	DeviceNet CANopen, 43
Cable diameter	$\varnothing 7.5 \text{ mm} \pm 0.30$
Cable length	10 m
Cable jacket	PUR, Gray
Shielding	no
Core insulation	PP

Cable Cross-Section

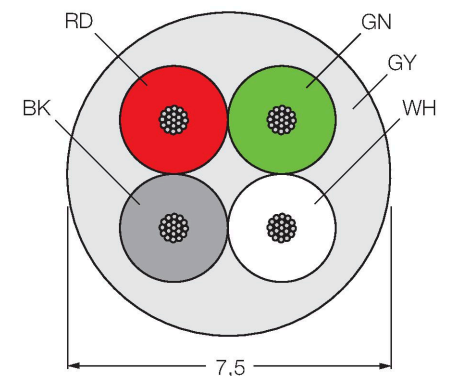

Contact assignment



Circuit Diagram



Technical data

Core cross-section	4 x 1.5 mm ²
Arrangement of strands	84 x 0.15 mm
Core colors	BK, RD, GN, WH
Electrical properties at +20 °C	
Rated voltage	250 V
Test voltage	500 V
Current	12 A
Mechanical and chemical properties	
Bending radius (flexible use)	≥ 10 x Ø
Ambient temperature range (stationary)	-40...+90 °C
Ambient temperature range (In motion)	-30...+90 °C
Ambient temperature during drag chain operation	0...+90 °C
Other Features	
Qualified for drag chain use	yes
Halogen-free	yes
Oil-resistant	yes
Flame-retardant	yes