

Power Cable Extension Cable RSM-WKM20-5M

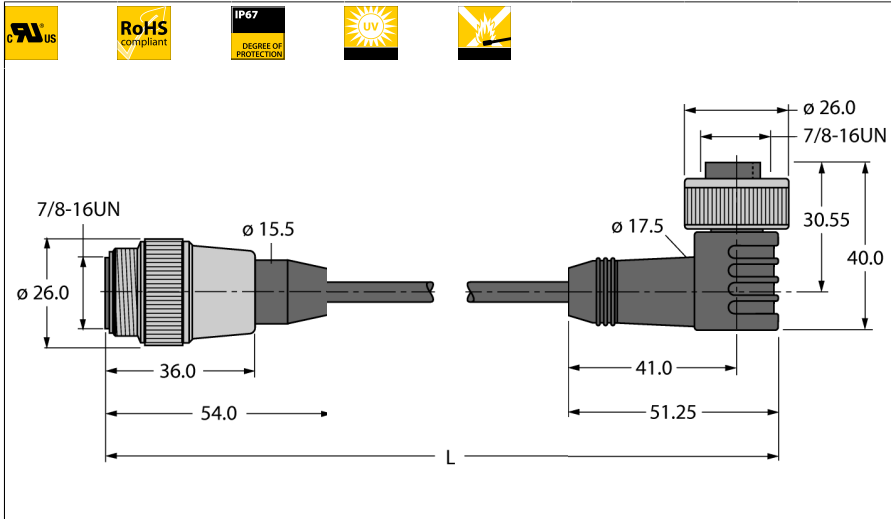

- Power cable: $2 \times 0.83 \text{ mm}^2$, 2 × 18 AWG
- Jacket material: PVC
- Jacket color: yellow
- Jacket diameter: 6.2 mm
- UV resistant
- Flame retardant acc. to CSA FT4
- UL, CSA approval
- RoHS compliant
- Protection class: NEMA 1, 3, 4, 6P and IEC IP67
- 7/8" female, angled
- 7/8" male, straight
- Cable length: 5.0 m

Type	RSM-WKM20-5M
ID	6915263

Connector A	Male, 7/8"-16 UN, Straight
Number of Pins	2
Contacts	Metal, CuZn, Gold-plated
Contact carriers	Plastic, TPU, Yellow
Connector body	Plastic, TPU, Yellow
Coupling nut/screw	Brass, CuZn, Nickel-plated
Protection class	IP67, Only in screwed condition
Mechanical lifespan	> 100 Mating cycles
Pollution degree	3

Connector B	Female, 7/8"-16 UN, Angled
Number of pins	2 pins
Contacts	Metal, CuZn, Gold-plated
Contact carriers	Plastic, TPU, Yellow
Connector body	Plastic, TPU, Yellow
Coupling nut/retaining screw	Brass, CuZn, Nickel-plated
Protection class	IP67, Only when screwed together
Mechanical life	> 100 Mating cycles
Pollution degree	3

General data	
Cable diameter	6.2 ± 0.20
Cable length	5 m
Cable quality	PVC
Cable color	Yellow
Core insulation	PVC
Core colors	BN, BU
Core cross-section	$2 \times 0.83 \text{ mm}^2$
Arrangement of strands	$19 \times 0.25 \text{ mm}$

Electrical properties at +20 °C	
Current	9 A
Voltage	600 V



Circuit Diagram

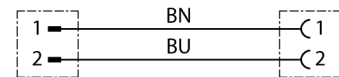

Mechanical and chemical properties	
Bending radius (stationary installation)	$\geq 5 \times \varnothing$
Bending radius (flexible use)	$\geq 10 \times \varnothing$
Ambient temperature range (stationary)	-40...+105°C