

RSSW 458-6M PROFIBUS Cable – PUR Cable Jacket

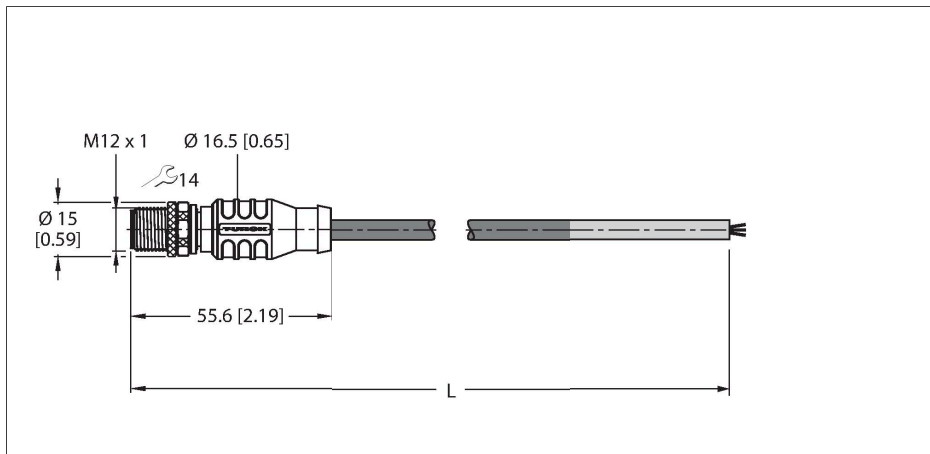

Features



- Jacket material: PUR
- Jacket color: purple
- Suitable for drag chain use
- UL approval
- Protection class: IP67
- End open
- Cable length: 6.0 m

Cable Cross-Section

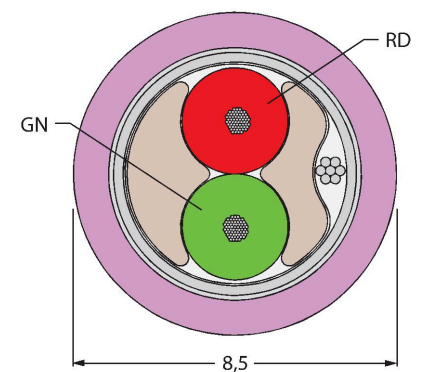

Technical data

Type	RSSW 458-6M
ID	U0349-7
Connector A	Male, M12 × 1, Straight, B-coded
Number of Pins	5
Contacts	Metal, CuZn, Gold-plated
Contact carriers	Plastic, TPU, Black
Connector body	Plastic, TPU, Black
Coupling nut/screw	Brass, CuZn, Nickel-plated
Tightening torque (range)	0.8 ... 1 Nm (observe max. torque of mating connector!)
Mechanical lifespan	> 100 Mating cycles
Pollution degree	3
Protection class	IP67, Only in screwed condition
Cable	
Network protocol	PROFIBUS-DP, 458
Cable diameter	Ø 8.5 mm ±0.30
Cable length	6 m
Cable jacket	PUR, Violet
Shielding	Aluminum foil, tinned copper wire
Core insulation	PE
Core cross-section	2 x 0.34 mm ²
Arrangement of strands	65 x 0.079 mm
Core colors	GN, RD
Electrical properties at +20 °C	
Rated voltage	250 V
Current	4 A
DC resistance (loop)	50 Ω/km

Technical data

Nom. impedance	150 Ω (1MHz)
Nom. capacitance	29.53 pF/m
Mechanical and chemical properties	
Bending radius (stationary installation)	≥ 5 x Ø
Bending radius (flexible use)	≥ 15 x Ø
Bending cycles	≥ 10 million
Torsional stress	± 180 °/m
Ambient temperature range (stationary)	-40...+80 °C
Ambient temperature range (In motion)	-40...+60 °C
Ambient temperature during drag chain operation	-25...+60 °C
Other Features	
Qualified for drag chain use	yes
Halogen-free	no
UV resistance	yes
Flame-retardant	yes
Approvals	UL CSA
Note	
- We reserve the right to make technical modifications without prior notice.	