

Actuator and Sensor Cable, PUR Quick-turn Connection Cable RKC4Q-2/TXL

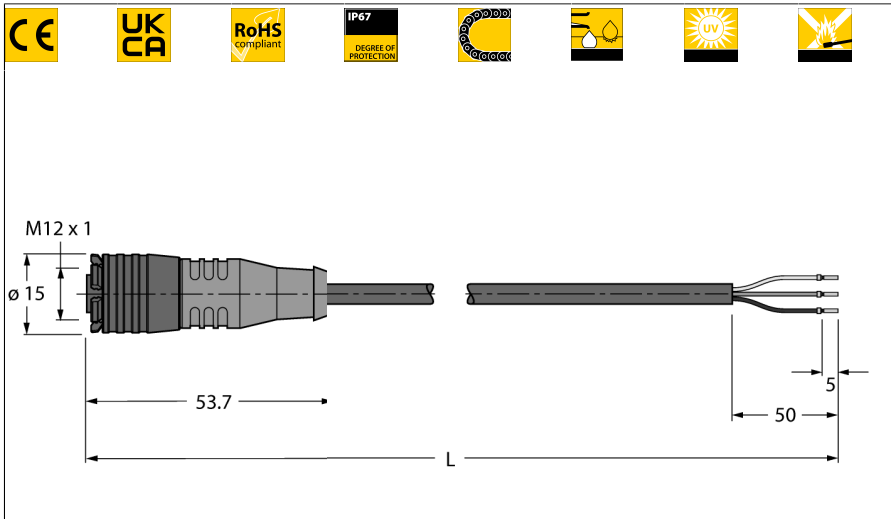

- Female M12, straight, 3-pin
- Sheath material: PUR
- Sheath color: black
- Qualified for drag chain use
- Resistant to weld splatter
- Resistant to chemicals, UV radiation and oils
- Flame retardant
- Free from halogen, silicone, PVC and LABS
- Particularly resistant to abrasion
- RoHS conform
- Protection class IP67
- Cable length: 2.0 m

| | |
|------|-------------|
| Type | RKC4Q-2/TXL |
| ID | 6628010 |

| | |
|---------------------|------------------------------------|
| Connector A | Female, M12 × 1, Straight, A-coded |
| Number of Pins | 3 |
| Contact carriers | Plastic, TPU, Black |
| Connector body | Plastic, TPU, Yellow |
| Interlocking sleeve | Plastic, PBT, black |
| Mechanical lifespan | > 50 Mating cycles |
| Pollution degree | 3 |
| Protection class | IP67, (plugged) |

| | |
|------------------------|--------------------------|
| Cable | |
| Cable diameter | Ø 4.1mm ±0.20 |
| Cable length | 2 m m |
| Cable jacket | PUR, Black |
| Core insulation | PP |
| Core cross-section | 3 x 0.34 mm ² |
| Arrangement of strands | 42 x 0.1mm |
| Core colors | BN, BU, BK |

| | |
|---------------------------------|--------------|
| Electrical properties at +20 °C | |
| Rated voltage | 250V |
| Test voltage | 2000 V |
| Current | 4AA |
| Insulation resistance | > 30.5 MΩ/km |
| forward resistance | max. 57 Ω/km |

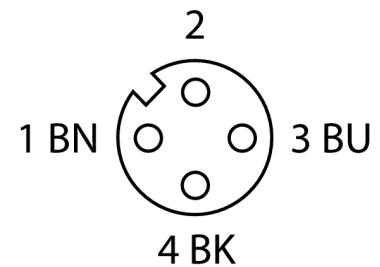

Circuit Diagram

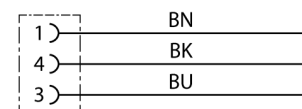

| Mechanical and chemical properties | |
|---|------------------------------|
| Bending radius (stationary installation) | $\geq 5 \times \varnothing$ |
| Bending radius (flexible use) | $\geq 10 \times \varnothing$ |
| Bending cycles | ≥ 5 million |
| Admissible acceleration | max. 5 m/s ² |
| Admissible travel path, horizontal | 5 m (at 5 m/s ²) |
| Admissible travel path, vertical | 2 m (at 5 m/s ²) |
| Admissible traversing speed | 3.3 m/s |
| Torsional stress | $\pm 180^\circ/\text{m}$ |
| Ambient temperature range (stationary) | -50...+80°C |
| Ambient temperature range (In motion) | -25...+80°C |
| Ambient temperature during drag chain operation | -25...+60°C |

Accessories

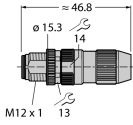
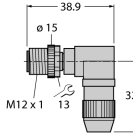
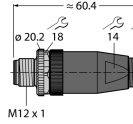
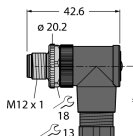
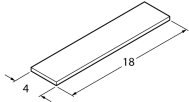
| Type code | Ident no. | | Dimension drawing |
|----------------------------------|-----------|---|--|
| HAS8141-0 | 6905406 | Field-wireable male connector, M12 × 1, straight, 4-pin, insulation piercing connection, cable feedthrough 4.0 to 5.1 mm, core cross-section/terminal capacity 0.14 to 0.34 mm ² , plastic housing, metal nut |  <p>Technical drawing of the HAS8141-0 connector showing dimensions: total length ≈ 46.8 mm, diameter ø 15.3 mm, and terminal spacing 14 mm and 13 mm. The connector is labeled M12 x 1.</p> |
| HAS8241-0 | 6905400 | Field-wireable male connector, M12 × 1, angled, 4-pin, insulation piercing connection, cable feedthrough 4.0 to 5.1 mm, core cross-section/terminal capacity 0.14 to 0.34 mm ² , plastic housing, metal nut |  <p>Technical drawing of the HAS8241-0 angled connector showing dimensions: total length 38.9 mm, diameter ø 15 mm, and terminal spacing 13 mm and 13 mm. The connector is labeled M12 x 1.</p> |
| BS8141-0 | 69010 | Field-wireable male connector, M12 × 1, straight, 4-pin, screw terminal connection, cable feedthrough 4.0 to 6.0 mm, core cross-section/terminal capacity 0.14 to 0.75 mm ² , plastic housing, metal retaining screw |  <p>Technical drawing of the BS8141-0 screw terminal connector showing dimensions: total length ≈ 60.4 mm, diameter ø 20.2 mm, and terminal spacing 18 mm, 14 mm, and 13 mm. The connector is labeled M12 x 1.</p> |
| BS8241-0 | 69011 | Field-wireable connector, M12 × 1, angled, 4-pin, screw terminal connection, cable feedthrough 4.0 to 6.0 mm, core cross-section/terminal capacity 0.14 to 0.75 mm ² , plastic housing, metal retaining screw |  <p>Technical drawing of the BS8241-0 angled screw terminal connector showing dimensions: total length 42.6 mm, diameter ø 20.2 mm, and terminal spacing 18 mm, 18 mm, and 13 mm. The connector is labeled M12 x 1.</p> |
| BLANK-LABEL-FOR-CORDSETS-TEL-TXL | 6936206 | Label for TEL and TXL cables, length: 18 mm, height: 4 mm, material: polycarbonate (PC), color: white, halogen-free and flame-retardant |  <p>Technical drawing of the label showing dimensions: length 18 mm and height 4 mm.</p> |