

T30RW3FF200Q1

Photoelectric Sensor – Diffuse Mode Sensor with Fixed-Field Background Suppression

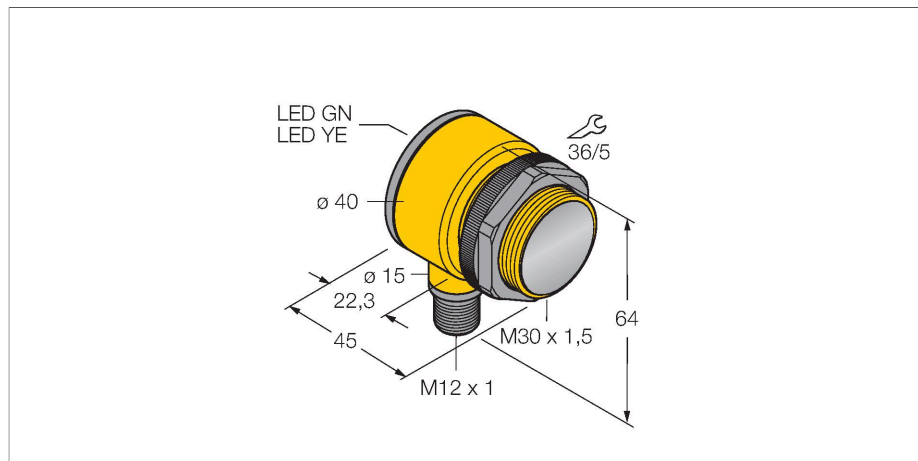

Technical data

Type	T30RW3FF200Q1
ID no.	3033432
Optical data	
Function	Proximity switch
Operating mode	Background suppression, non-adjustable
Light type	IR
Wavelength	880 nm
Range	0...200 mm
Electrical data	
Operating voltage	20...250 VAC
AC rated operational current	≤ 200 mA
Output function	Dark operation, Relay output
Switching frequency	≤ 40 Hz
Readiness delay	≤ 100 ms
Response time typical	< 16 ms
Mechanical data	
Design	Rectangular with thread, T30
Dimensions	Ø 30 x 45 x 40 x 64 mm
Housing material	Plastic, Thermoplastic material
Lens	plastic, Acrylic
Electrical connection	Connectors, 1/2", PVC
Number of cores	4
Ambient temperature	-40...+70 °C
Protection class	IP69
Special features	Encapsulated Wash down

Features

- M12 × 1 male connector, 4-pin
- Protection classes IP67/IP69K
- Ambient temperature: -40 °C...+70 °C

Wiring diagram

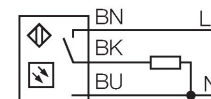

Functional principle

The emitter and receiver are incorporated in a single housing. The light reflection of the target is detected and triggers the sensor to switch. Thus the switching distance largely depends on the reflectivity of the target.

Excess gain curve

Excess gain in relation to the distance

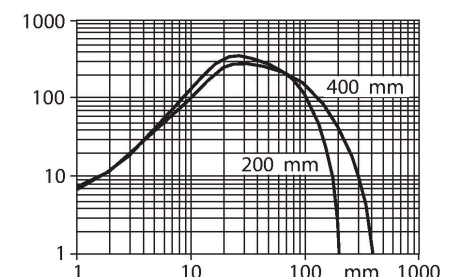

Technical data

Power-on indication	LED, Green
Switching state	LED, Yellow
Excess gain indication	LED
Tests/approvals	
MTTF	448 years acc. to SN 29500 (Ed. 99) 40 °C
Approvals	CE, UL, CSA

Accessories

SMB1815SF

3053279

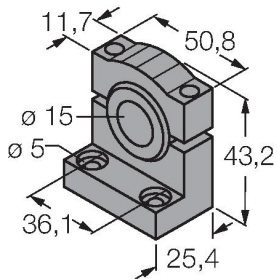

Mounting bracket, PBT black, for PICO-GUARD points

SMB30A

3032723

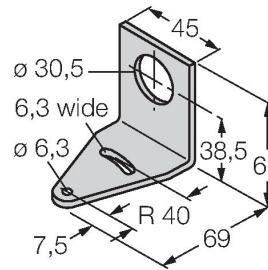

Mounting bracket, rectangular, stainless steel, for sensors with 30mm thread

SMB30FAM10

3011185

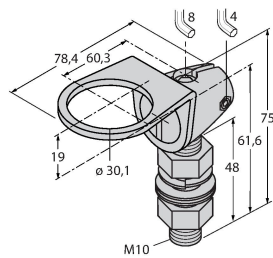

Mounting bracket, stainless steel, for M10 x 1.5 thread, thread length 30 mm

SMBAMS30P

3073135

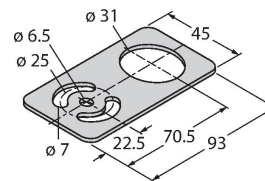

Mounting bracket, stainless steel, for sensors with 30 mm thread