

M18SN6R W/30

Photoelectric Sensor – Opposed Mode Sensor (Receiver)

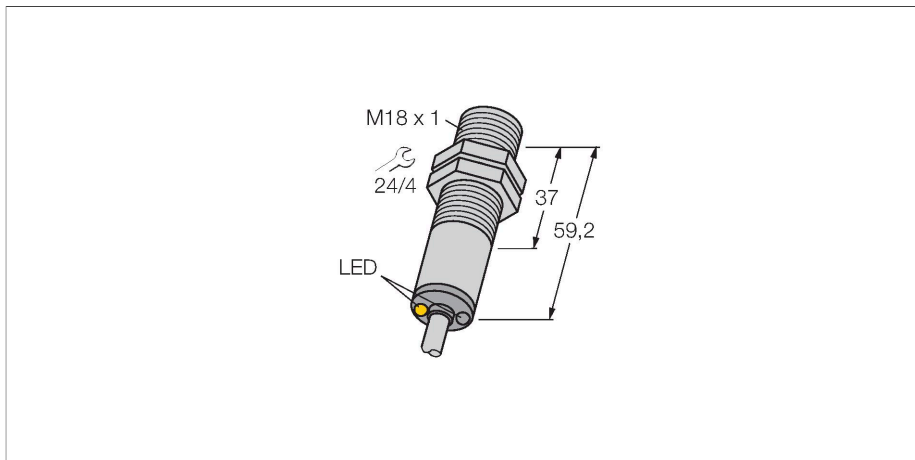

Technical data

Type	M18SN6R W/30
ID no.	3050466
Optical data	
Function	Opposed mode sensor
Operating mode	Receiver
Range	0...20000 mm
Electrical data	
Operating voltage	10...30 VDC
No-load current	≤ 25 mA
Short-circuit protection	yes / Cyclic
Reverse polarity protection	yes
Output function	Connection programmable, NPN
Switching frequency	≤ 160 Hz
Readiness delay	≤ 100 ms
Response time typical	< 3 ms
Overcurrent release	> 220 mA
Mechanical data	
Design	Threaded barrel, M18
Dimensions	Ø 18 x 59.2 mm
Housing material	Metal, Stainless steel
Lens	plastic, Polycarbonate
Electrical connection	Cable, 9 m, PVC
Number of cores	4
Core cross-section	0.5 mm ²
Ambient temperature	-40...+70 °C
Protection class	IP69
Special features	Chemical-resistant

Features

- Cable, 2 m
- Protection class IP67
- Ambient temperature: -40...+70 °C
- Metal housing
- Selectable light/dark operation or light operation with alarm function
- Operating voltage: 10...30 VDC
- NPN switching output, changeover

Wiring diagram

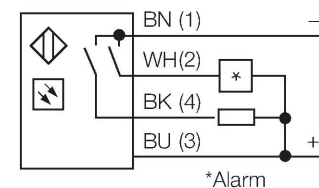
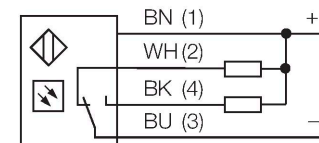

Functional principle

Opposed mode sensors consist of an emitter and receiver. They are installed opposite each other so that the light from the emitter is aimed directly at the receiver. When an object interrupts or weakens the light beam, the sensor switches. Opposed mode sensors are the most reliable photoelectric sensors for detection of opaque targets. An excellent contrast between light and dark conditions and an extremely high excess gain are typical of this sensing mode, thus allowing operation over larger distances and under difficult conditions. Excess gain curve
Excess gain in relation to the distance

Technical data

	Encapsulated Wash down
Power-on indication	LED, Green
Switching state	LED, Yellow
Error indication	LED, green, Flashing
Excess gain indication	LED
Alarm display	LED yellow Flashing
Tests/approvals	
Approvals	CE

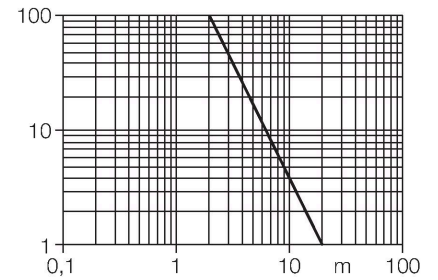

Accessories

SMB18A

3033200

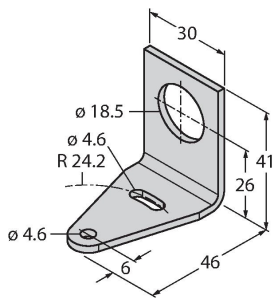

Mounting bracket, rectangular, stainless steel, for sensors with 18 mm thread

SMB18AFAM10

3012558

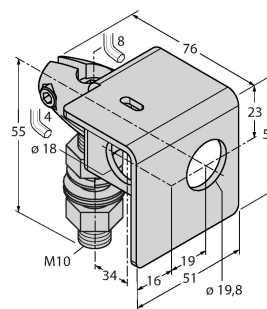

Mounting bracket, material VA 1.4401, for M10 x 1.5 thread, thread length 18 mm

SMB3018SC

3053952

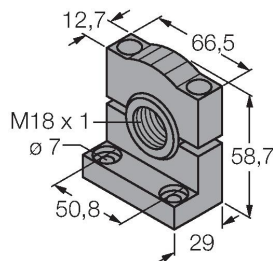

Mounting bracket, PTB black, for sensors with 18 mm thread

SMBAMS18P

3073134

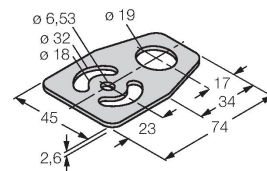

Mounting bracket, stainless steel, for sensors with 18 mm thread