

S18RW3REQ1

Photoelectric Sensor – Opposed Mode Sensor (Receiver)

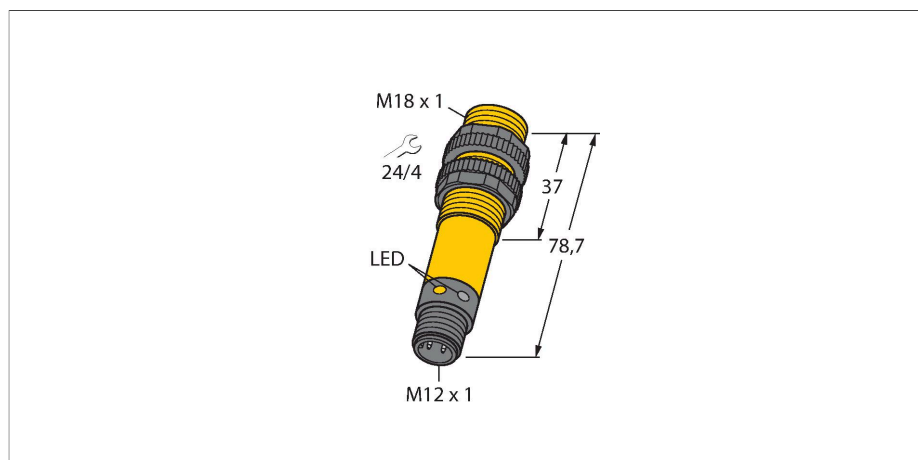

Technical data

Type	S18RW3REQ1
ID no.	3037083
Optical data	
Function	Opposed mode sensor
Operating mode	Emitter/receiver pair
Range	0...20000 mm
Electrical data	
Operating voltage	20...250 VAC
AC rated operational current	≤ 200 mA
Output function	Dark operation, Relay output
Switching frequency	≤ 40 Hz
Readiness delay	≤ 100 ms
Response time typical	< 16 ms
Mechanical data	
Design	Threaded barrel, S18
Dimensions	Ø 18 x 78.7 mm
Housing material	Plastic, Thermoplastic material
Lens	plastic, Polycarbonate
Electrical connection	Connectors, 1/2", PVC
Number of cores	4
Ambient temperature	-40...+70 °C
Protection class	IP67 IP69
Special features	Encapsulated Wash down
Power-on indication	LED, Green
Switching state	LED, Yellow
Excess gain indication	LED

Features

- M12 × 1 male connector, 4-pin
- Protection classes IP67/IP69K
- Ambient temperature: -40 °C...+70 °C
- Selectable light/dark operation or light operation with alarm function

Wiring diagram

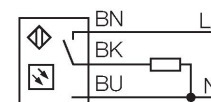

Functional principle

Opposed mode sensors consist of an emitter and receiver. They are installed opposite each other so that the light from the emitter is aimed directly at the receiver. When an object interrupts or weakens the light beam, the sensor switches. Opposed mode sensors are the most reliable photoelectric sensors for detection of opaque targets. An excellent contrast between light and dark conditions and an extremely high excess gain are typical of this sensing mode, thus allowing operation over larger distances and under difficult conditions. Excess gain curve

Excess gain in relation to the distance

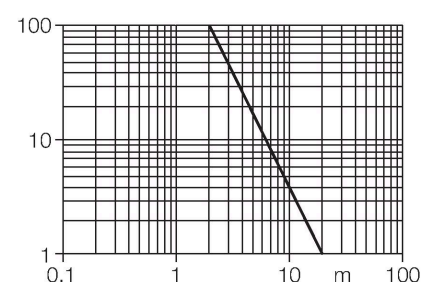

Technical data

Tests/approvals

Approvals

CE, UL, CSA

Accessories

SMB18A

3033200

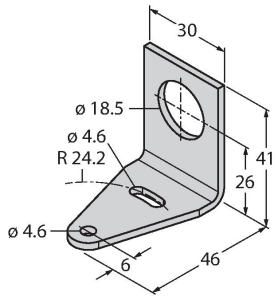

Mounting bracket, rectangular, stainless steel, for sensors with 18 mm thread

SMB18AFAM10

3012558

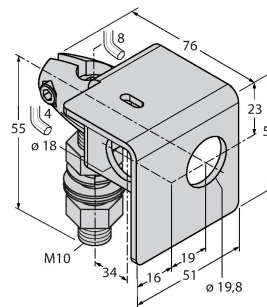

Mounting bracket, material VA 1.4401, for M10 x 1.5 thread, thread length 18 mm

SMB3018SC

3053952

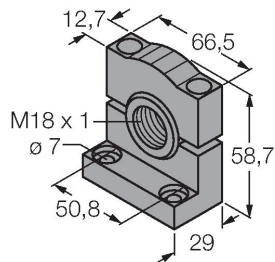

Mounting bracket, PTB black, for sensors with 18 mm thread

SMBAMS18P

3073134

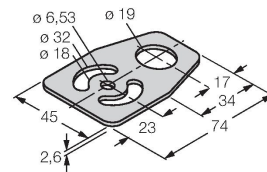

Mounting bracket, stainless steel, for sensors with 18 mm thread