

NI3-EG08K-AN6X-V1131

Inductive Sensor

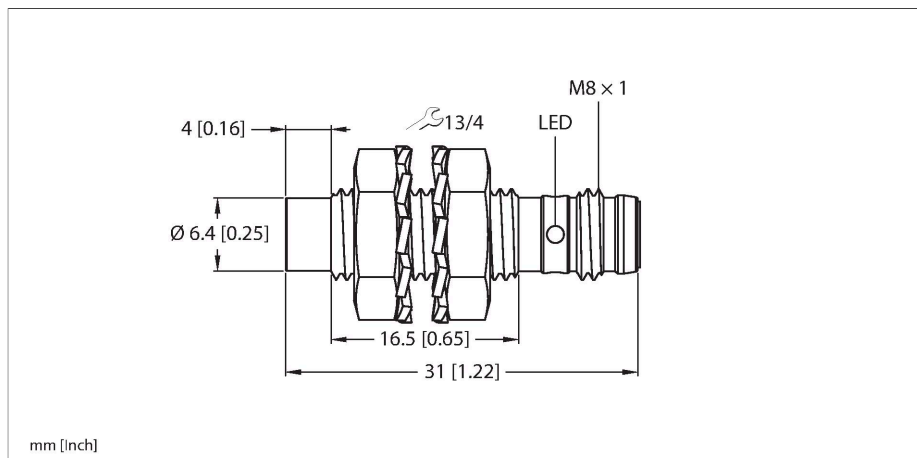

Technical data

Type	NI3-EG08K-AN6X-V1131
ID	4669750
General data	
Rated switching distance	3 mm
Mounting conditions	Non-flush
Secured operating distance	$\leq (0.81 \times S_n)$ mm
Correction factors	St37 = 1; Al = 0.3; stainless steel = 0.7; Ms = 0.4
Repeat accuracy	$\leq 2\%$ of full scale
Temperature drift	$\leq \pm 10\%$
Hysteresis	20 %
Electrical data	
Operating voltage	10...30 VDC
Residual ripple	$\leq 10\% U_{ss}$
DC rated operational current	≤ 150 mA
No-load current	15 mA
Residual current	≤ 0.1 mA
Isolation test voltage	≤ 0.5 kV
Short-circuit protection	yes / Cyclic
Voltage drop at I_o	≤ 1.8 V
Wire breakage/Reverse polarity protection	yes / Complete
Output function	3-wire, NO contact, NPN
Switching frequency	3 kHz
Mechanical data	
Design	Threaded barrel, M8 x 1
Dimensions	31 mm
Housing material	Stainless steel, 1.4305 (AISI 303)

Features

- M8 x 1 threaded barrel
- Stainless steel, 1.4305 (AISI 303)
- DC 3-wire, 10...30 VDC
- NO contact, NPN output
- M8 x 1 male connector

Wiring diagram

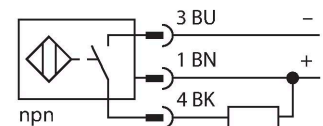

Functional principle

Inductive sensors detect metal objects contactless and wear-free. For this, they use a high-frequency electromagnetic AC field that interacts with the target. Inductive sensors generate this field via an RLC circuit with a ferrite coil.

Technical data

Active area material	Plastic, PBT
Max. tightening torque of housing nut	5 Nm
Electrical connection	Connector, M8 × 1
Environmental conditions	
Ambient temperature	-25...+70 °C
Vibration resistance	55 Hz (1 mm)
Shock resistance	30 g (11 ms)
Protection class	IP67
MTTF	2283 years acc. to SN 29500 (Ed. 99) 40 °C
Switching state	LED, Yellow

Mounting instructions

Mounting instructions/Description



Distance D	3 x B
Distance W	3 x Sn
Distance T	3 x B
Distance S	1.5 x B
Distance G	6 x Sn
Distance N	2 x Sn
Diameter active area B	Ø 8 mm

Accessories

BST-08B

6947210

Mounting clamp for threaded barrel sensors, with dead-stop; material: PA6

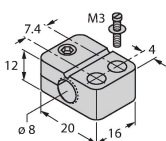

QM-08

6945100

Quick-mount bracket with dead-stop, chrome-plated brass, male thread M12 x 1. Note: The switching distance of proximity switches may be reduced through the use of quick-mount brackets.

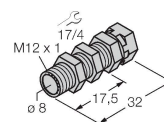

MW-08

6945008

Mounting bracket for threaded barrel sensors; material: Stainless steel A2 1.4301 (AISI 304)

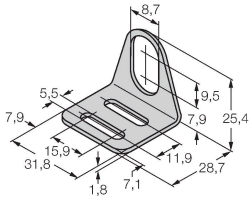

BSS-08

6901322

Mounting clamp for smooth and threaded barrel sensors; material: Polypropylene

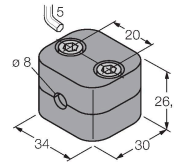

MBS80

69479

Mounting clamp for smooth barrel sensors; mounting block material: Anodized aluminum

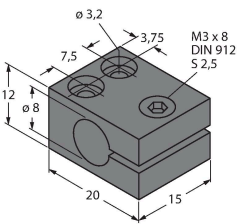

Accessories

Dimension drawing	Type	ID	
	PKG3M-2/TEL	6625385	Connection cable, M8 female connector, straight, 3-pin, stainless steel coupling nut, cable length: 2 m, jacket material: PVC, black; cULus approval

