

K50RPFF100GXDQP

Pick-to-Light – Placement Sensor

Diffuse Mode Sensor with Fixed-field Background Suppression

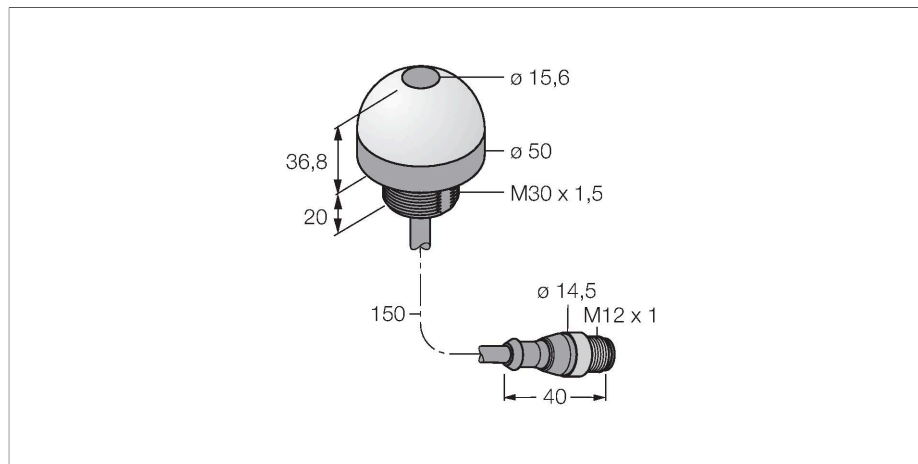

Features

- Protection class IP67
- Cable with M12 × 1 male connector, 4-pin, 150 mm
- Fixed background suppression at 100 mm
- Job light: green
- Mispick: not signalled
- Actuation: not signalled
- Operating voltage 12...30 VDC
- PNP switching
- NC contact

Wiring diagram

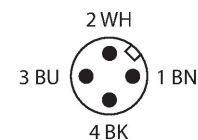
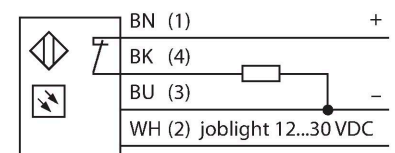

Technical data

Type	K50RPFF100GXDQP
ID	3076008
Signal and display data	
Purpose	Pick-to-Light
Function	Diffuse mode sensor with fixed-field background suppression
Max. range	100 mm
Light type	IR
Number of beams	1
Switch Function	Momentary
Features of color 1	Green, Permanently on
Special features	I/O module-compatible Wash down
Electrical data	
Operating voltage	12...30 VDC
DC rated operational current	≤ 150 mA
Max. current consumption per color	75 mA
Output function	NC contact, PNP
Input type	PNP
Response time typical	< 3 ms
Mechanical data	
Design	Dome, K50
Dimensions	Ø 50 x 56.8 mm
Housing material	Plastic, PC, Black
Window material	Polycarbonate, diffuse

Functional principle

The K50 pick-and-place sensor is suitable for many mounting and component placement applications. The green work light or other signal lights are reflected perfectly by the entire dome (depending on the version). The transistor output can be easily connected to a system control, which is programmed for a special task sequence. The work light of the sensor is located in or next to every bin at the operator's workstation and indicates: 1. The bins with the components to be picked up for a particular work step and 2. the sequence in which the components have to be picked up. If the operator removes a part from the bin, the K50 detects the hand in the bin and sends a signal to the control unit. The system then checks if the correct component has been picked up and – depending on the configuration – switches the corresponding work light off and the next one on, according to the assembly sequence. The work sequence control leads to increased efficiency, improved quality control and reduces rework and testing expenses. The term work light therefore refers to the visual indicator of the bin from which a part should be removed next. The actuation indicator confirms the removal with a different

Technical data

Electrical connection	Cable with connector, M12 × 1, 0.15 m, PVC
Number of cores	4
Ambient temperature	-40...+50 °C
Relative humidity	0...90 %
Protection class	IP67 IP69
Tests/approvals	
MTTF	146 years acc. to SN 29500 (Ed. 99) 40 °C
Approvals	CE, cULus listed

color. The mispick indicator illuminates if a bin was reached into when the work light was not set.

Accessories

SMB30A 3032723

Mounting bracket, rectangular, stainless steel, for sensors with 30mm thread

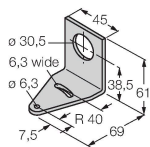

SMB30SC 3052521

Mounting bracket, PBT black, for sensors with 30 mm thread, rotatable

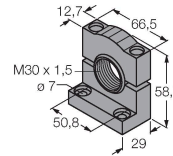

SMB30FA 3074005

Montagewinkel; Werkstoff VA 1.4401

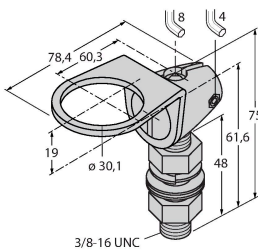

Accessories

Dimension drawing	Type	ID	
	RKC4.4T-2/TEL	6625013	Connection cable, M12 female connector, straight, 4-pin, cable length: 2 m, jacket material: PVC, black; cULus approval

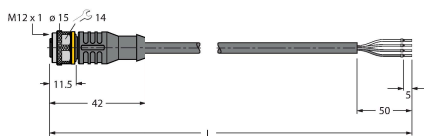

Dimension drawing

Type

WKC4.4T-2/TEL

ID

6625025

Connection cable, M12 female connector, angled, 4-pin, cable length: 2 m, jacket material: PVC, black; cULus approval

