

QS18VN6FF100 W/30

Photoelectric Sensor – Diffuse Mode Sensor with Fixed-Field Background Suppression

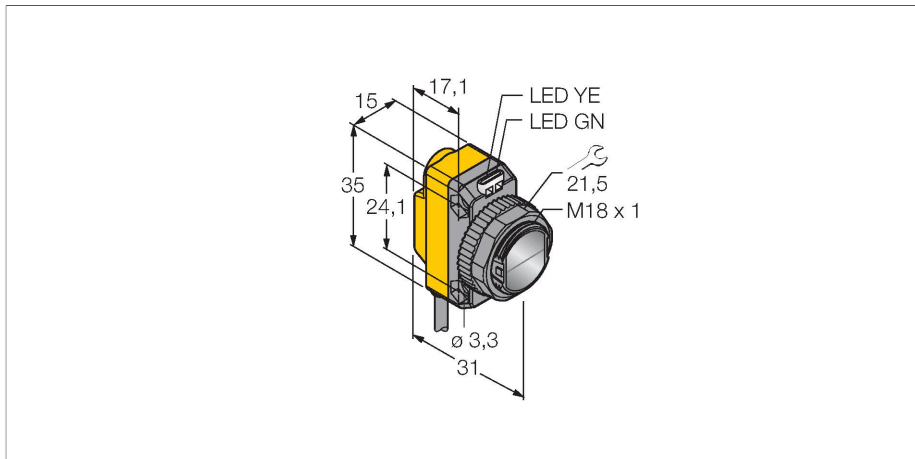

Technical data

Type	QS18VN6FF100 W/30
ID no.	3072093
Optical data	
Function	Proximity switch
Operating mode	Background suppression, non-adjustable
Light type	Red
Wavelength	630 nm
Range	0...100 mm
Electrical data	
Operating voltage	10...30 VDC
Residual ripple	< 10 % U _{ss}
DC rated operational current	≤ 100 mA
Short-circuit protection	yes
Reverse polarity protection	yes
Output function	NO/NC, NPN
Current output	100 mA
Switching frequency	≤ 625 Hz
Readiness delay	≤ 100 ms
Response time typical	< 0.85 ms
Mechanical data	
Design	Rectangular with thread, QS18
Dimensions	Ø 18 x 31 x 15 x 35 mm
Housing material	Plastic, ABS
Lens	plastic, Acrylic
Electrical connection	Cable, 9 m, PVC
Number of cores	4

Features

- Cable, PVC, 9 m
- Protection class IP67
- LED all-round visible
- Operating voltage: 10...30 VDC
- NPN switching output, changeover

Wiring diagram

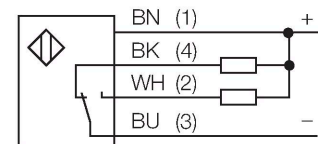

Functional principle

Diffuse mode sensors with background suppression operate with a single emitter and several receiver elements. The target position and the photoelectric structure of the sensor determine which of the receiving elements receives the most light. The sensor electronics determine whether the reflecting object is within or outside the measuring range. These sensors come with a fixed cut-off point.

Excess gain curve
Excess gain in relation to the distance

Technical data

Core cross-section	0.35 mm ²
Ambient temperature	-20...+70 °C
Protection class	IP67
Power-on indication	LED, Green
Switching state	LED, Yellow
Error indication	LED, green, Flashing
Excess gain indication	LED, yellow, flashing
Tests/approvals	
MTTF	965 years acc. to SN 29500 (Ed. 99) 40 °C
Approvals	CE, cURus

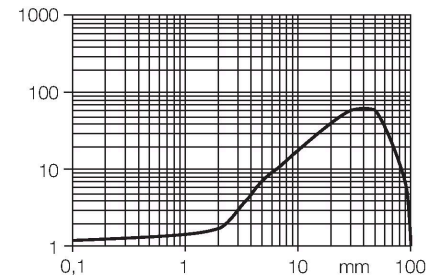

Accessories

SMB18A

3033200

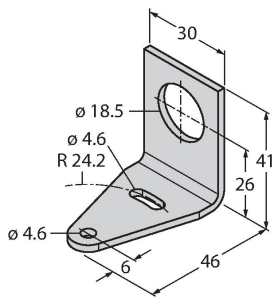

Mounting bracket, rectangular, stainless steel, for sensors with 18 mm thread

SMB18AFAM10

3012558

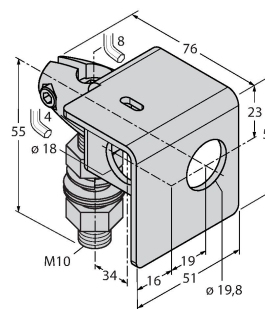

Mounting bracket, material VA 1.4401, for M10 x 1.5 thread, thread length 18 mm

SMBQS18A

3069721

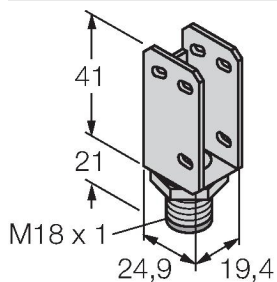

Mounting bracket, stainless steel, for 18 mm thread

SMB18SF

3052519

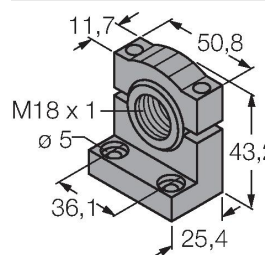

Mounting bracket, PBT black, for sensors with 18 mm thread, rotatable