



EN Operating Instructions . . . . . pages 1 to 5  
Original

**Content**

**1 About this document**

1.1 Function . . . . . 1

1.2 Target group: authorised qualified personnel. . . . . 1

1.3 Explanation of the symbols used . . . . . 1

1.4 Appropriate use . . . . . 1

1.5 General safety instructions . . . . . 1

1.6 Warning about misuse . . . . . 1

1.7 Exclusion of liability . . . . . 2

**2 Product description**

2.1 Ordering code . . . . . 2

2.2 Special versions. . . . . 2

2.3 Purpose . . . . . 2

2.4 Technical data . . . . . 2

2.5 Safety classification . . . . . 2

**3 Mounting**

3.1 General mounting instructions . . . . . 3

3.2 Dimensions . . . . . 4

**4 Electrical connection**

4.1 General information for electrical connection. . . . . 4

4.2 Contact Options . . . . . 4

**5 Set-up and maintenance**

5.1 Functional testing. . . . . 4

5.2 Maintenance . . . . . 4

**6 Disassembly and disposal**

6.1 Disassembly. . . . . 4

6.2 Disposal . . . . . 4

**7 EU Declaration of conformity**

**1. About this document**

**1.1 Function**

This operating instructions manual provides all the information you need for the mounting, set-up and commissioning to ensure the safe operation and disassembly of the safety switchgear. The operating instructions must be available in a legible condition and a complete version in the vicinity of the device.



**1.2 Target group: authorised qualified personnel**

All operations described in this operating instructions manual must be carried out by trained specialist personnel, authorised by the plant operator only.

Please make sure that you have read and understood these operating instructions and that you know all applicable legislations regarding occupational safety and accident prevention prior to installation and putting the component into operation.

The machine builder must carefully select the harmonised standards to be complied with as well as other technical specifications for the selection, mounting and integration of the components.

**1.3 Explanation of the symbols used**

-  **Information, hint, note:**  
This symbol indicates useful additional information.
-  **Caution:** Failure to comply with this warning notice could lead to failures or malfunctions.
-  **Warning:** Failure to comply with this warning notice could lead to physical injury and/or damage to the machine.

**1.4 Appropriate use**

The Schmersal range of products is not intended for private consumers.

The products described in these operating instructions are developed to execute safety-related functions as part of an entire plant or machine. It is the responsibility of the manufacturer of a machine or plant to ensure the correct functionality of the entire machine or plant.

The safety switchgear must be exclusively used in accordance with the versions listed below or for the applications authorised by the manufacturer. Detailed information regarding the range of applications can be found in the chapter "Product description".

**1.5 General safety instructions**

The user must observe the safety instructions in this operating instructions manual, the country specific installation standards as well as all prevailing safety regulations and accident prevention rules.

 Further technical information can be found in the Schmersal catalogues or in the online catalogue on the Internet: [products.schmersal.com](http://products.schmersal.com).

The information contained in this operating instructions manual is provided without liability and is subject to technical modifications. There are no residual risks, provided that the safety instructions as well as the instructions regarding mounting, commissioning, operation and maintenance are observed.

**1.6 Warning about misuse**

 In case of improper use or manipulation of the safety switchgear, personal hazards or damages to machinery or plant components cannot be excluded.

### 1.7 Exclusion of liability

We shall accept no liability for damages and malfunctions resulting from defective mounting or failure to comply with this operating instructions manual. The manufacturer shall accept no liability for damages resulting from the use of unauthorised spare parts or accessories.

For safety reasons, invasive work on the device as well as arbitrary repairs, conversions and modifications to the device are strictly forbidden, the manufacturer shall accept no liability for damages resulting from such invasive work, arbitrary repairs, conversions and/or modifications to the device.

## 2. Product description

### 2.1 Ordering code

This operating instructions manual applies to the following types:

#### ZQ 900-①②③

No.	Option	Description
①	11	1 NO contact / 1 NC contact
	13	1 NO contact / 3 NC contacts
	22	2 NO contacts / 2 NC contacts
	02	2 NC contacts
②	04	4 NC contacts
	N	without emergency-stop button with emergency-stop button
③		Cable entry 3x M20
	STC2 FB	Connector plug, M12, A-coded, 4-pole Connector plug, M12, A-coded, 8-pole



Only if the information described in this operating instructions manual are realised correctly, the safety function and therefore the compliance with the Machinery Directive is maintained.

### 2.2 Special versions

For special versions, which are not listed in the order code below 2.1, these specifications apply accordingly, provided that they correspond to the standard version.

### 2.3 Purpose

Pull-wire emergency stop switches are used on machinery and plants, where triggering the emergency stop command must be enabled at arbitrary points on the wire run. If the tensioned pull-wire is pulled or in case of wire breakage or if the optional emergency stop switch is pushed, the switching function of the pull-wire emergency stop switch is activated (refer to image 1).

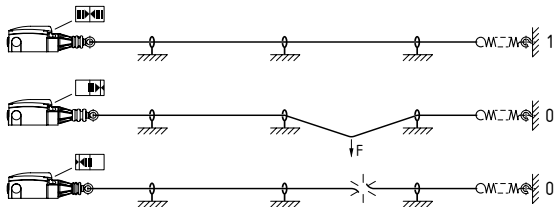

Image 1: Position indication and actuation

### Design/operating principle

The pull-wire emergency stop switches of the ZQ 900 series are brought into the operational condition by the proper pre-tensioning of the wire. Up to two switching elements located on the inside of the switch have either 2 or 4 contacts, whereby the NC contacts are closed and the NO contacts are opened in tensioned condition.

After actuation of the emergency stop function, a latching mechanism maintains the stop command until the switch is released by pushing the blue reset button. Prior to the reset of the emergency stop signal, the reason why the switch has been actuated must be determined. The switch can only be reset if the switch is correctly pre-tensioned (position indication in central position, refer to image 1).

The ZQ 900-FB is for use in combination with the safety field box SFB made by Schmersal.



The user must evaluate and design the safety chain in accordance with the relevant standards and the required safety level.



The entire concept of the control system, in which the safety component is integrated, must be validated to the relevant standards.

### 2.4 Technical data

Standards:	EN 60947-5-1, EN 60947-5-5, EN 620, EN ISO 13850
Enclosure:	zinc die-cast, paint
Cover:	thermoplastic
Degree of protection:	IP65, IP67 to EN 60529
- ZQ 900-...-N:	IP65
Protection class:	I
Degree of pollution:	3
Contact material:	Silver
Switching system:	Change-over contact with double break, 1 to 4 NC contacts, snap action with positive break NC contacts
Termination:	screw terminals or connector plug M12, A-coded, 4-pole or 8-pole
Cable section:	max. 2.5 mm <sup>2</sup> (incl. conductor ferrules)
Cable entry:	3x M20
Utilisation category AC-15, DC-13 I <sub>e</sub> /U <sub>e</sub> :	
- Screw terminal connection	4 A / 240 V/AC, 1 A / 24 V/DC
- Plug connector M12, 4-pole	4 A / 240 V/AC, 1 A / 24 V/DC
- Plug connector M12, 8-pole	2 A / 24 V/AC, 1 A / 24 V/DC
Rated impulse withstand voltage U <sub>imp</sub> :	
- Screw terminal connection	6 kV
- Connector plug M12, 4-pole	2.5 kV
- Connector plug M12, 8-pole	0.8 kV
Rated insulation voltage U <sub>i</sub> :	
- Screw terminal connection	500 V
- Connector plug M12, 4-pole	250 V
- Connector plug M12, 8-pole	32 V
Thermal test current I <sub>the</sub> :	
- Screw terminal connection	10 A
- Connector plug M12, 4-pole	4 A
- Connector plug M12, 8-pole	2 A
Short circuit resistance:	
- Screw terminal connection	6 A gG D-fuse
- Connector plug M12, 4-pole	4 A gG D-fuse
- Connector plug M12, 8-pole	2 A gG D-fuse
Required rated short-circuit current:	1,000 A
Ambient temperature:	-25 °C ... +70 °C
Wire length:	max. 75 m depending in relation to the range of ambient temperature (see image 4)
Mechanical life:	> 1.000.000 operations



Input terminal wire size AWG: 14-22  
Max. Torque: 7 Lb In  
Use solid or stranded copper conductors only.

### 2.5 Safety classification

Standards:	EN ISO 13849-1
B <sub>10D</sub> NC contact:	100,000
Mission time:	20 years

$$MTTF_D = \frac{B_{10D}}{0,1 \times n_{op}} \quad n_{op} = \frac{d_{op} \times h_{op} \times 3600 \text{ s/h}}{t_{cycle}}$$

(Determined values can vary depending on the application-specific parameters  $h_{op}$ ,  $d_{op}$  and  $t_{cycle}$  as well as the load.)

If multiple safety components are wired in series, the Performance Level to EN ISO 13849-1 will be reduced due to the restricted error detection under certain circumstances.

### 3. Mounting

#### 3.1 General mounting instructions



The installation may only be carried out with the system de-energised and by authorised personnel.

The pull-wire emergency stop switch is fitted by means of two screws (distance of the drill holes 40 mm or 48 mm), so that a release by hand can be realised without hazard.



The device must be arranged so that unlocking by hand is entirely without risk and that the entire length of the wire can be seen from the switch.



In accordance with EN 60947-5-5 (EN 620), the maximum perpendicular traction force to be exercised on the wire in order to activate the emergency pull-wire switch is 200 N (125 N), the maximum deflection is 400 mm (300 mm). Sufficient space must be provided so that the required actuating deflection can be reached. It must be ensured that when tensioned, the wire rope always follows a straight course and that it remains in the correct position at all times (including at the redirection point). External influences (temperature variations, ageing) can affect the properties of the wire rope. The information in EN ISO 13850 must be observed.

For lengths of over 10 m, intermediate wire supports must be installed after max. 3 m. To avoid resonance vibrations in the wire on machines with high vibrations, it is recommended to realise the individual support length differently. Assembly: refer to image 2.

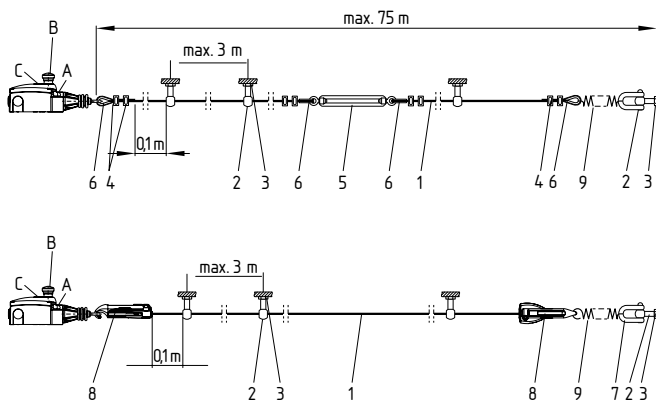

Image 2: Mounting of the components

#### Key

- |   |                       |   |  |
|---|-----------------------|---|--|
| A | Position indicator    | 1 | Pull-wire with red PVC jacket, Ø 5 mm (steel core: Ø 3 mm) |
| B | Emergency-Stop button | 2 | Eyebolt  |
| C | Reset button          | 3 | Nut  |
|   |                       | 4 | Wire clamp   |
|   |                       | 5 | Tensioner  |
|   |                       | 6 | Wire thimble   |
|   |                       | 7 | Shackle  |
|   |                       | 8 | Wire tensioner S900  |
|   |                       | 9 | Tension spring ACC-RS900-TS                                |

We recommend the use of the ACC-RS900-TS tension spring to reduce the effects of temperature variations.

Due to the thermal expansion behaviour of the wire, the maximum authorised length of wire is determined by the ambient temperature change (refer to image 4).



In order to ensure an optimal operation safety and to save time during fitting, we recommend using the wire rope and the combined fixing and tensioning system from Schmersal. Alternatively, wire thimbles and wire clamps can be used in conjunction with a tensioner. In this case, the red PVC sheet must be removed in the clamp area prior to installing the wire rope.

As the thimbles are subject to deformation in case of wire pull, the wire should be pulled several times after fitting. After that, the wire must be re-tensioned (see image 3).

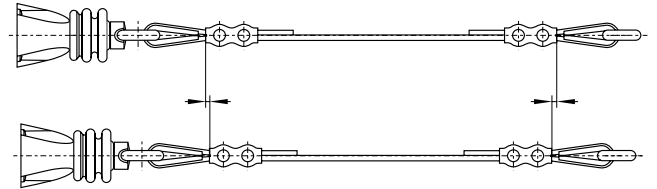
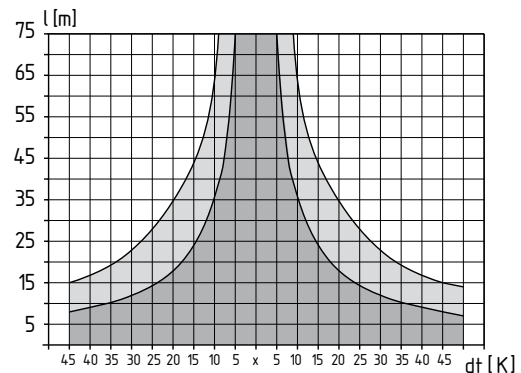

Image 3: Thimble deformation

Correct operation of the product is directly connected to the data shown in the diagram. The maximum wire length depends on the temperature change to which the hauling wire system is exposed. The corresponding wire length with and without external tension spring is shown in the diagram.



- x Reference temperature
- without tension spring
- ▨ with tension spring

Image 4: temperature-dependent maximum length of wire with or without tension spring

The pull-wire must be fixed to the ring and then be pre-tensioned until the position indication is in the central position (refer to image 1).

### 3.2 Dimensions

All measurements in mm.

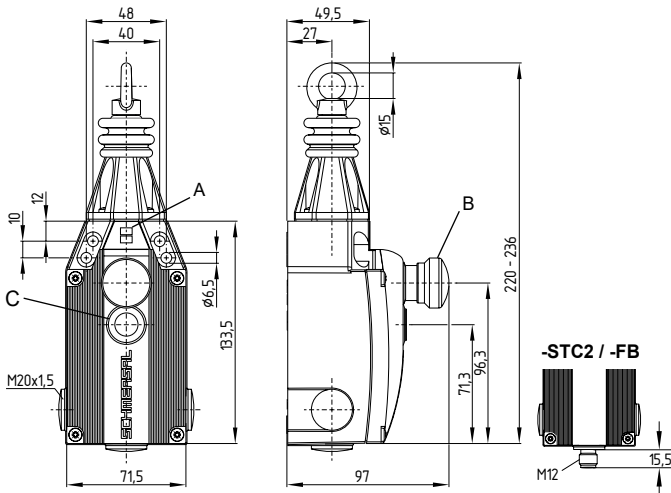

#### Key

- A Position indication
- B Emergency-Stop button
- C Reset button

## 4. Electrical connection

### 4.1 General information for electrical connection



The electrical connection may only be carried out by authorised personnel in a de-energised condition.

1. Cover screws must be loosened
2. Dust shield cap remove
3. Cable glands M20 x 1.5 with an appropriate degree of protection must be used
4. When wiring, please ensure that no cables are located within the range of the lever system and the pushbutton
5. The inside of the switch must be imperatively cleaned (e.g. removal of cable residues), considering that foreign bodies can affect the switching behaviour
6. Unused cable entries must be sealed by means of locking screws, included in delivery (tightening torque 4 Nm)
7. The cover screws must be tightened uniformly (tightening torque 1 Nm)

#### Accessories cable gland

Ordering code: 103006011  
 Authorised cable diameter: 6 ... 12 mm  
 Tightening torque: 8 Nm

#### Settle length x of the conductor: 6 mm



### 4.2 Contact Options

Contacts shown in a de-energised condition.

Pin assignment of versions with M12 connector shown in brackets.

All NC contacts have positive break  $\ominus$ .

#### ZQ 900-11

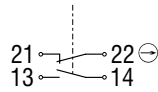

#### ZQ 900-02(-STC2)

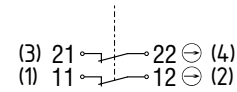

#### ZQ 900-13

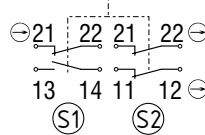

#### ZQ 900-22

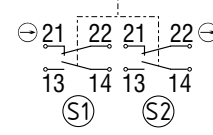

#### ZQ 900-04

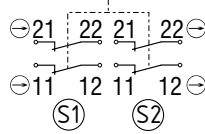

#### ZQ 900-02-FB

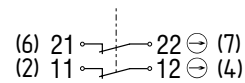

#### Connector STC2

M12  
4-pole



#### Connector FB

M12  
8-pole

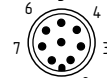

## 5. Set-up and maintenance

### 5.1 Functional testing

The safety function of the safety components must be tested.

The following conditions must be previously checked and met:

1. Check the correct fitting of the pull-wire emergency stop switch
2. Check the integrity of the cable entry and connections
3. Check the switch enclosure for damage
4. Check the functionality of the switch by actuating the wire
5. Check the cable tensioning by means of the position indicator

### 5.2 Maintenance

A regular visual inspection and functional test, including the following steps, is recommended:

1. Check the functionality of the switch by actuating the wire and, if applicable, the emergency stop switch
2. Check the cable entries and the wire connections
3. Remove particles of dust and soiling
4. Check the wire tension through the wire position indication and check the wire and the wire guides for damage and correct fitting



Do not open the device under tension.

**Damaged or defective components must be replaced.**

## 6. Disassembly and disposal

### 6.1 Disassembly

The safety switchgear must be disassembled in a de-energised condition only.

### 6.2 Disposal

The safety switchgear must be disposed of in an appropriate manner in accordance with the national prescriptions and legislations.

7. EU Declaration of conformity

EU Declaration of conformity



Original  
ACE Schmersal  
Eletroeletrônica Industrial Ltda.  
Av. Brasil, nº 815  
Jardim Esplanada  
CEP: 18557-646 Boituva – SP  
Brazil  
Internet: www.schmersal.com.br

We hereby certify that the hereafter described components both in their basic design and construction conform to the applicable European Directives.

**Name of the component:** ZQ 900

**Type:** See ordering code

**Description of the component:** Pull-wire emergency stop switches

**Relevant Directives:** 2006/42/EC Machinery Directive  
2011/65/EU RoHS-Directive

**Applied standards:** EN 60947-5-1:2017 + AC:2020  
EN 60947-5-5:1997 + A1:2005 + A11:2013 + A2:2017  
EN 620:2002 + A1:2010  
EN ISO 13850:2015

**Person authorised for the compilation of the technical documentation:** Oliver Wacker  
Möddinghofe 30  
42279 Wuppertal

**Place and date of issue:** Boituva, March 14, 2023

Authorised signature  
**Marco Antonio De Dato**  
Head of Engineering and Design

ACE-ZQ900-F-EN



The currently valid declaration of conformity can be downloaded from the internet at [products.schmersal.com](http://products.schmersal.com).



**K.A. Schmersal GmbH & Co. KG**  
Möddinghofe 30, 42279 Wuppertal  
Germany  
Phone: +49 202 6474-0  
Fax: +49 202 6474-100  
E-Mail: [info@schmersal.com](mailto:info@schmersal.com)  
Internet: [www.schmersal.com](http://www.schmersal.com)

Production site:  
**ACE Schmersal**  
Eletroeletrônica Industrial Ltda.  
Av. Brasil, nº 815  
Jardim Esplanada – CEP: 18557-646, Boituva – SP  
Brazil  
Phone: +55 - (0)15 - 32 63 - 9866  
Fax: +55 - (0)15 - 32 63 - 9890  
E-Mail: [vendas@schmersal.com.br](mailto:vendas@schmersal.com.br)  
Internet: <http://www.schmersal.com.br>