



EN Operating instructions.pages 1 to 8
Original

Content

1 About this document

1.1 Function 1

1.2 Target group: authorised qualified personnel. 1

1.3 Explanation of the symbols used 1

1.4 Appropriate use 1

1.5 General safety instructions 1

1.6 Warning about misuse 2

1.7 Exclusion of liability 2

2 Product description

2.1 Ordering code 2

2.2 Special versions. 2

2.3 Purpose 2

2.4 Safety distance 2

2.5 Technical data 3

2.6 Safety classification 3

3 Mounting

3.1 General information 3

3.2 Dimensions 3

3.3 Accessories SMS 4 3

3.4 Mounting SMS 4 4

3.5 Mounting SMS 5 4

3.6 Cable laying 5

4 Electrical connection

4.1 Electrical connection 6

5 Set-up and maintenance

5.1 Functional testing. 6

5.2 Maintenance 6

6 Disassembly and disposal

6.1 Disassembly. 6

6.2 Disposal 6

7 Appendix

7.1 Wiring example 7

8 EU Declaration of conformity

1. About this document

1.1 Function

This operating instructions manual provides all the information you need for the mounting, set-up and commissioning to ensure the safe operation and disassembly of the safety switchgear. The operating instructions must be available in a legible condition and a complete version in the vicinity of the device.

1.2 Target group: authorised qualified personnel

All operations described in this operating instructions manual must be carried out by trained specialist personnel, authorised by the plant operator only.

Please make sure that you have read and understood these operating instructions and that you know all applicable legislations regarding occupational safety and accident prevention prior to installation and putting the component into operation.

The machine builder must carefully select the harmonised standards to be complied with as well as other technical specifications for the selection, mounting and integration of the components.

1.3 Explanation of the symbols used



Information, hint, note:

This symbol is used for identifying useful additional information.



Caution: Failure to comply with this warning notice could lead to failures or malfunctions.

Warning: Failure to comply with this warning notice could lead to physical injury and/or damage to the machine.

1.4 Appropriate use

The Schmersal range of products is not intended for private consumers.

The products described in these operating instructions are developed to execute safety-related functions as part of an entire plant or machine. It is the responsibility of the manufacturer of a machine or plant to ensure the correct functionality of the entire machine or plant.

The safety switchgear must be exclusively used in accordance with the versions listed below or for the applications authorised by the manufacturer. Detailed information regarding the range of applications can be found in the chapter "Product description".

1.5 General safety instructions

The user must observe the safety instructions in this operating instructions manual, the country specific installation standards as well as all prevailing safety regulations and accident prevention rules.



Further technical information can be found in the Schmersal catalogues or in the online catalogue on the Internet: products.schmersal.com.

The information contained in this operating instructions manual is provided without liability and is subject to technical modifications.

There are no residual risks, provided that the safety instructions as well as the instructions regarding mounting, commissioning, operation and maintenance are observed.

1.6 Warning about misuse



In case of improper use or manipulation of the safety switchgear, personal hazards or damages to machinery or plant components cannot be excluded. The relevant requirements of the standard EN ISO 13855 must be observed.

1.7 Exclusion of liability

We shall accept no liability for damages and malfunctions resulting from defective mounting or failure to comply with this operating instructions manual. The manufacturer shall accept no liability for damages resulting from the use of unauthorised spare parts or accessories.

For safety reasons, invasive work on the device as well as arbitrary repairs, conversions and modifications to the device are strictly forbidden, the manufacturer shall accept no liability for damages resulting from such invasive work, arbitrary repairs, conversions and/or modifications to the device.

2. Product description

2.1 Ordering code

These mounting instructions apply to the following types:

SMS ①-②

No.	Option	Description
①	4	Without ramp profile
	5	With moulded ramp profile
②		Width x Length
	250-500	250 x 500 mm
	500-500	500 x 500 mm
	500-1000	500 x 1000 mm
	750-1000	750 x 1000 mm
	1000-1000	1000 x 1000 mm
	1000-1500	1000 x 1500 mm



Only if the information described in this operating instructions manual are realised correctly, the safety function and therefore the compliance with the Machinery Directive is maintained.

2.2 Special versions

For special versions, which are not listed in the order code below 2.1, these specifications apply accordingly, provided that they correspond to the standard version.

2.3 Purpose

Safety mats are used for the protection of man on machinery and plants with hazardous movements. Typical fields of application are, for instance, the protection of hazardous areas and surfaces on wood-processing machines, scissor lifts or punching presses. The safety mats build a uniplanar safety device, which detects the presence of persons. The safety mats consist of two separate current-carrying steel plates. Insulating layers separate the plates from each other. Upon actuation of the pressure-sensitive mat, an electrical cross-wire short is produced between the steel plates. If a person steps onto the safety mat, the connected safety-monitoring module will immediately stop the hazardous movement.



The complete safety system comprises (a) switch mat(s) and an SRB-E-301ST, SRB301HC/R or SRB301HC/T safety module or PROTECT-SELECT safety module. The safety mats of the SMS 4 and SMS 5 series must not be used without safety-monitoring module. Otherwise, the test certificate becomes void.



The user must evaluate and design the safety chain in accordance with the relevant standards and the required safety level.

2.4 Safety distance



During the design of the protection, the stopping time, the approach speed of the operating staff, the safety distance as well as stepping over and the manipulation of the safety guard must be considered in particular. The adequacy of dimensioning and mounting must ensure that the operators cannot reach the nearest danger point before the machine has come to a standstill. The standard EN ISO 13855 (Safety of Machinery, Approaching Speed of Body Members) provides a formula to calculate the safety distance

Calculation formula to EN ISO 13855:

$$S = K \times (T1 + T2) + (1200 - 0,4 H)$$

- S** Minimum safety distance in millimetres, measured from the hazardous area to the detection point, the detection line or the protected field
- K** Constant in millimetres per second, derived from data through the approaching speed of the body or the body member (1600 mm/s)
- H** Distance through the reference plane (e.g. the floor) in millimetres (for safety mats generally 0 mm)
- T1** the maximum response time of the safety device between the triggering of the perceptive element (the safety mat) and the time, at which the safety guard (safety-monitoring module) has switched the output signal to the "OFF" state
- T2** the response time of the machine, i.e. the time required to shutdown the machine or to eliminate the risk, after the transmission of the output signal of the safety guard

The safety distance therefore generally can be calculated in the following way:

$$S = 1600 \text{ mm/s} \times (T1 + T2) + 1200 \text{ mm}$$

Example:

The safety distance must be calculated with a response time of 142.5 ms for the machine and a response time of 45 ms for the safety guard. The safety mat is installed at ground level.

$$S = 1600 \text{ mm/s} \times (0.045 \text{ s} + 0.1425 \text{ s}) + 1200 \text{ mm}$$

$$S = 1600 \text{ mm/s} \times (0,1875 \text{ s}) + 1200 \text{ mm}$$

$$S = 300 \text{ mm} + 1200 \text{ mm}$$

$$S = 1500 \text{ mm}$$



The entire concept of the control system, in which the safety component is integrated, must be validated to the relevant standards.

2.5 Technical data

Standards:	EN ISO 13856-1, EN ISO 13849-1
Surface material:	polyurethane, black, 68 ±5 Shore A
Degree of protection:	IP65 to EN 60529
Degree of pollution:	3
Ambient temperature:	0° C ... 60 °C
Fitting height:	14 mm
Weight:	24 kg/m ²
Actuating force:	150 N with round body Ø 80 mm
Cable:	
- SMS 4:	4 x 0.25 mm ²
- SMS 5:	2 pc. 2 x 0.25 mm ²
Cable length:	6 m
Response time:	≤ 25 ms
Mechanical life:	>1.5 million operations
Admissible load:	2,000 N / Ø 80 mm
Inactive edge:	≤ 10 mm

2.6 Safety classification

in combination with SRB-E-301ST, SRB301HC/R or SRB301HC/T or safety module PROTECT-SELECT

Standards:	EN ISO 13849-1
PL:	d
Control Category:	3
PFH:	4.2 x 10 ⁻⁸ /h; applicable for applications with up to max. 52,000 switching cycles / year and max. 60% contact load. Diverging applications upon request.
SIL:	suitable for SIL 2 applications
Mission time:	20 years

3. Mounting

3.1 General information

The mounting surface imperatively must be plane, clean and dry. Safety mats must not be glued. All cables must be protected against damages (crushing, shearing, etc.).

Position and align the safety mat at the desired position, the base plate facing down.

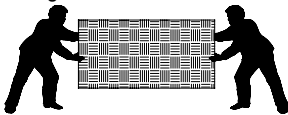

The Safety mats must not be bend or buckled.

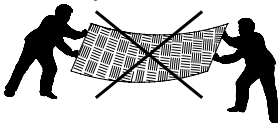

When multiple safety mats are arranged adjacently, their butts must be joined. The safety mats then must be wired (refer to chapter "Electrical connection").

3.2 Dimensions

All measurements in mm.

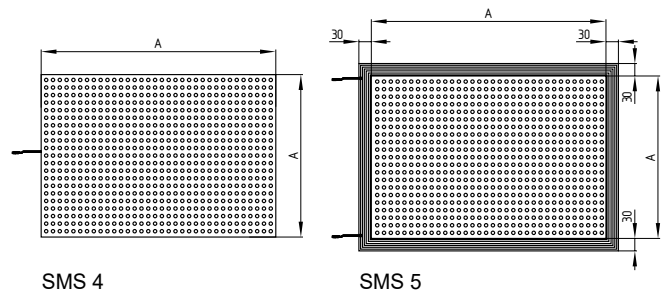

Key

A Active area
(Dimensions according to ordering index)

3.3 Accessories SMS 4

Ramp rail SMS 4-RS-3000

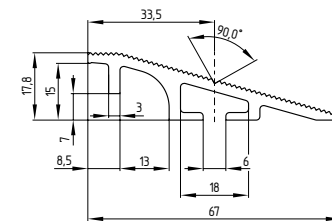

SMS 4-BS-3000 fixing rail

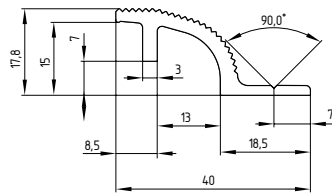

Corner section SMS 4-EV

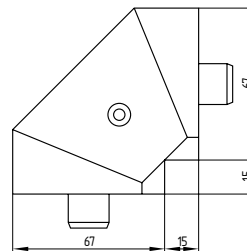

3.4 Mounting SMS 4

When the cable is laid in the ramp or fixing rail duct, crushing must be excluded. To use the corner section, the ramp rail of each corner section must be shortened by 20 mm.

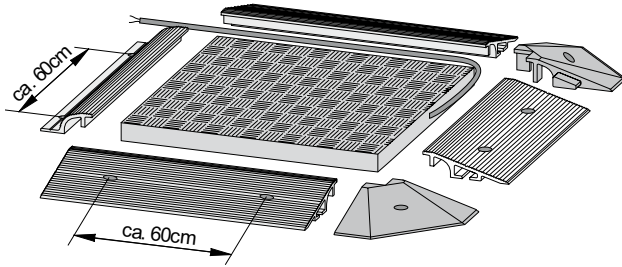

Insert the corner section in the cable area in such manner that the cable is led into the cable duct (figure 1). Then drill and fix them to the floor by means of 6 mm dowels and appropriate screws.

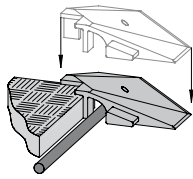

(Fig. 1)

Slide the ramp rails against the side of the mat and insert them in the guide pin of the corner section (fig. 2). Mark the fixing points on the rail along the marking nut and drill 10 mm for the provided plugs.

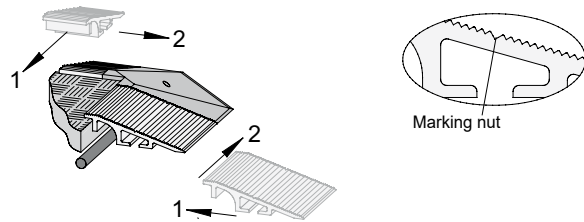

(Fig. 2)

Fix rails to substrate with 6 mm dowels and suitable screws (approx. every 60 cm) (fig.3).

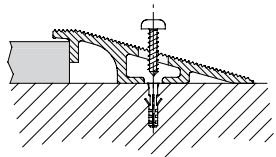

(Fig. 3)

Slide the other corner sections against the side of the mat and insert the guide pin into the rail socket (fig. 4). Then drill and fix them to the floor by means of 6 mm dowels and appropriate screws.

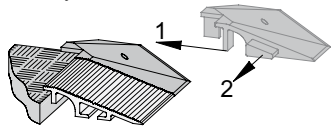

(Fig. 4)

The mounting is terminated by fixing the SMS 4-BS-3000 fixing rail on the machine side. Fix the cable rail to the floor by means of 6 mm dowels and appropriate screws (approx. every 60 cm). If possible, provide for a cable output on the side.(Fig. 5)

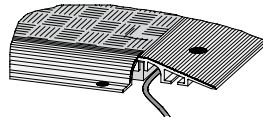

(Fig. 5)

Then realise the electrical connection of the safety mats (refer to chapter Electrical connection).

3.5 Mounting SMS 5

Position and align the safety mat at the desired position. Secure the safety mat on all sides against sliding and movement by means of appropriate screws and dowels (fig. 6).

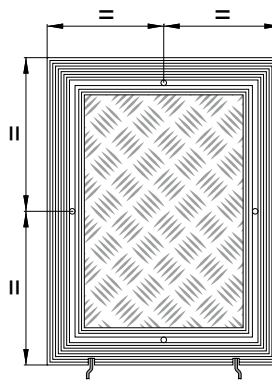

(Fig. 6)

Adjacent fitting of multiple mats

When multiple safety mats are arranged adjacently, their butts must be joined (fig. 7).

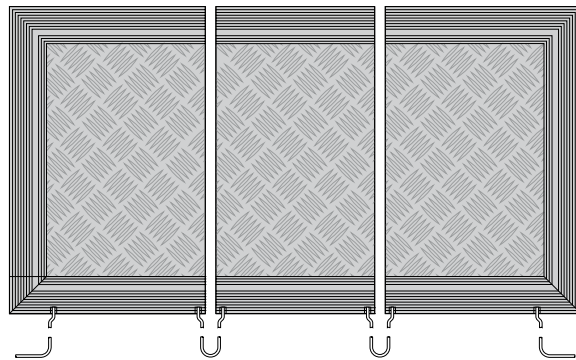

(Fig. 7)

To this end, the moulded ramp rails must be cut accordingly (fig. 8).

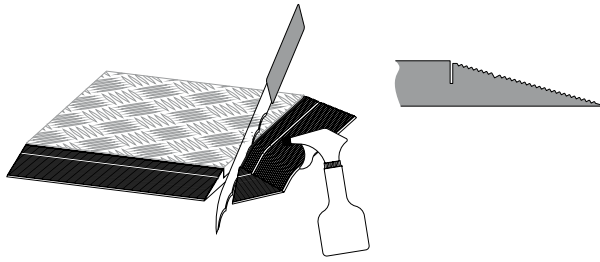

(Fig. 8)

Position and align the safety mats at the desired position. The safety mats then must be wired (refer to chapter "Electrical connection"). Secure the safety mat on all sides against sliding and movement by means of appropriate screws and dowels (fig. 9).

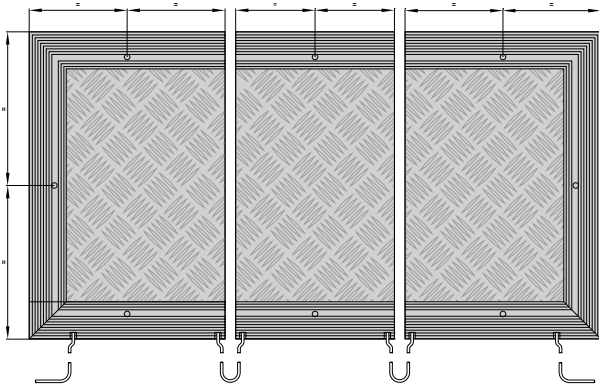

(Fig. 9)

Mounting the mats with ramp or fixing rail

The safety mats of the SMS 5 series can also be fixed by means of the SMS 4-RS-3000 and SMS 4-BS-3000 DIN rails. To this end, the moulded ramp rails must be removed and the DIN rails must be fitted as described in chapter 3.3.

3.6 Cable laying

Cable laying on the machine side

- Installing the safety mat directly below the machine body (fig. 10)
- Use of the SMS 4-BS-3000 fixing rail (fig. 11)
- Use of an on-site cable duct (fig. 12)

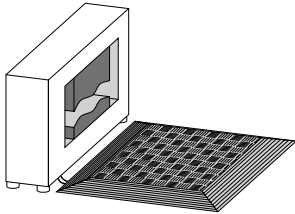

(Fig. 10)

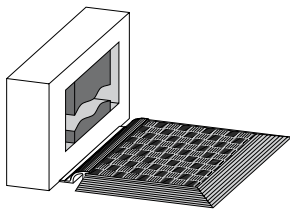

(Fig. 11)

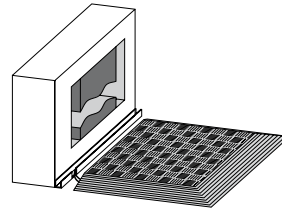

(Fig. 12)



When the SMS 4-BS-3000 aluminium profile is used, the moulded ramp profile must be removed, refer to fig. 8

Cable laying on the averted machine side

- Installing the safety mat directly on the machine (fig. 13)
- Use of the ramp rail (fig. 14)

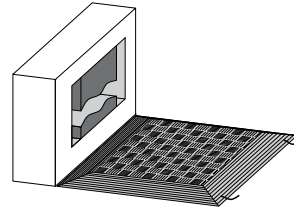

(Fig. 13)

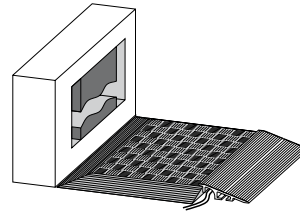

(Fig. 14)



When the SMS 4-BS-3000 aluminium profile is used, the moulded ramp profile must be removed, refer to fig. 8

Cable output

Strip the desired side of the cable output in such manner (fig. 15) to avoid subsequent squeezing or crushing of the cables (fig. 16).

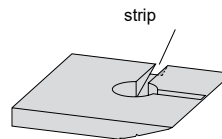

(Fig. 15)



(Fig. 16)

4. Electrical connection



The electrical connection may only be carried out by authorised personnel in a de-energised condition.

4.1 Electrical connection

The safety mats are connected through the permanently connected four-wire sheathed cable. The individual conductors of SMS 4 are marked by the numbers 1 ... 4, the conductors of SMS 5 have blue and brown coloured markings (fig. 17). To protect larger areas, several safety mats can be connected to form a large mat. Up to 5 safety mats can be connected to one safety monitoring module. To this end, individual safety mats are wired in series (see Fig. 18). The maximum loop impedance must be $<40\Omega$. Information on connecting the safety switch mat(s) can be found in the connection example in the appendix as well as in the operating instructions for the SRB-E-301ST, SRB301HC/R or SRB301HC/T safety module or PROTECT-SELECT safety module.

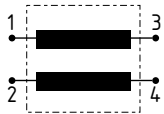

(Fig. 17)

Colour coding of wires	SMS 4	SMS 5
1	BN	BU
2	WH	BN
3	BU	BU
4	BK	BN



(Fig. 18)

5. Set-up and maintenance

5.1 Functional testing

The safety function of the safety mat must be tested. The following conditions must be previously checked and met:

1. Secure connection of the safety mats and the possible DIN rails to the subsoil
2. Fitting and integrity of the power cable

Step onto the safety mat to check whether the output relays of the safety-monitoring module are disabled and stop the hazardous movement of the machine.

5.2 Maintenance

A regular visual inspection and functional test, including the following steps, is recommended:

- Check the secure fixation of the safety mat and the possible DIN rails to the subsoil and check for damages
- Check the cable for damages
- Functional test to chapter 5.1

Damaged or defective components must be replaced.

6. Disassembly and disposal

6.1 Disassembly

The safety mat must be disassembled in de-energised condition only.

6.2 Disposal

The safety mat must be disposed of in an appropriate manner in accordance with the national prescriptions and legislations.

7. Appendix

7.1 Wiring example

The application examples shown are suggestions. They however do not release the user from carefully checking whether the switchgear and its set-up are suitable for the individual application.

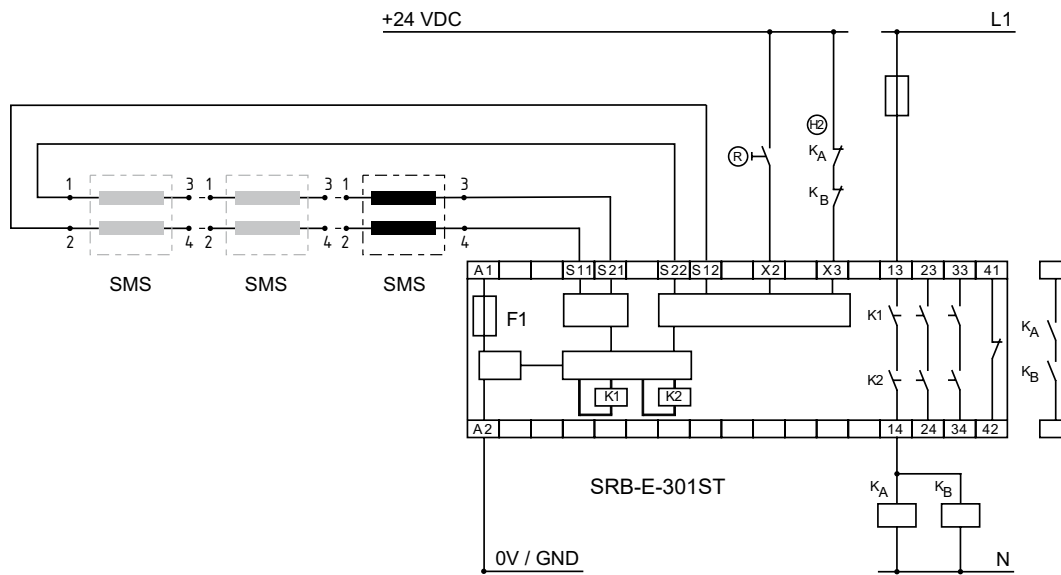

Rotary knob position	Function
12	Safety mat, Autostart
13	Safety mat, reset button

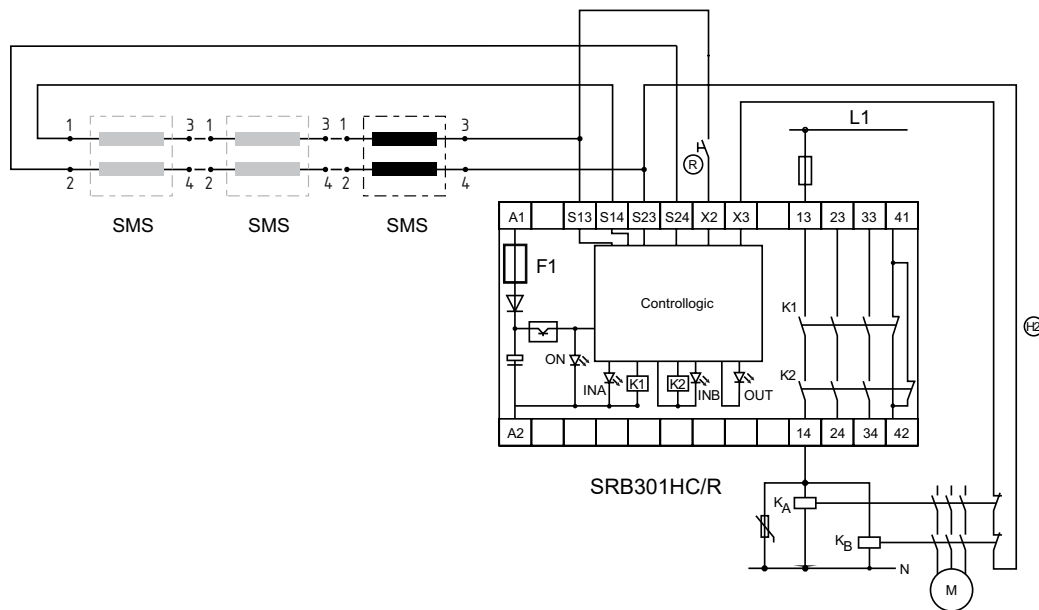

Key

- ⊕ Feedback circuit
- Ⓡ Reset button



Connection of an SMS switch mat to a PROTECT-SELECT safety module depends on the respective application program. Further information can be found in the operating instructions for the PROTECT-SELECT safety module.

8. EU Declaration of conformity

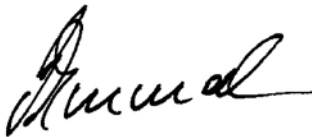
EU Declaration of conformity		 SCHMERSAL
Original	K.A. Schmersal GmbH & Co. KG Möddinghofe 30 42279 Wuppertal Germany Internet: www.schmersal.com	
We hereby certify that the hereafter described components both in their basic design and construction conform to the applicable European Directives.		
Name of the component:	SMS 4 SMS 5	
Type:	See ordering code	
Description of the component:	Safety mat with mit safety-monitoring module SRB-E-301ST, SRB301HC/R or SRB301HC/T or safety module PROTECT-SELECT	
Relevant Directives:	2006/42/EG Machinery Directive 2011/65/EU RoHS-Directive	
Applied standards:	EN ISO 13856-1:2013, EN ISO 13849-1:2015	
Notified body for the prototype test:	TÜV NORD CERT GmbH Langemarckstr. 20, 45141 Essen ID n°: 0044	
EC-prototype test certificate:	44 205 140 80001	
Person authorised for the compilation of the technical documentation:	Oliver Wacker Möddinghofe 30 42279 Wuppertal	
Place and date of issue:	Wuppertal, October 27, 2020	
		
	Authorised signature Philip Schmersal Managing Director	

SMS_4_5-G-EN



The currently valid declaration of conformity can be downloaded from the internet at products.schmersal.com.

