



**EN** Operating instructions. . . . . pages 1 to 4  
Original

**Content**

**1 About this document**

1.1 Function . . . . . 1

1.2 Target group: authorised qualified personnel. . . . . 1

1.3 Explanation of the symbols used . . . . . 1

1.4 Appropriate use . . . . . 1

1.5 General safety instructions . . . . . 1

1.6 Warning about misuse . . . . . 2

1.7 Exclusion of liability . . . . . 2

**2 Product description**

2.1 Ordering code . . . . . 2

2.2 Special versions. . . . . 2

2.3 Purpose . . . . . 2

2.4 Technical Data . . . . . 2

2.5 Safety classification . . . . . 2

**3 Mounting**

3.1 General mounting instructions. . . . . 3

3.2 Dimensions . . . . . 3

3.3 Settings . . . . . 3

3.4 Mounting of the actuating heads . . . . . 3

**4 Electrical connection**

4.1 General information for electrical connection. . . . . 4

4.2 Contact Options . . . . . 4

**5 Set-up and maintenance**

5.1 Functional testing. . . . . 4

5.2 Maintenance . . . . . 4

**6 Disassembly and disposal**

6.1 Disassembly. . . . . 4

6.2 Disposal . . . . . 4

**7 Declaration of conformity**

**1. About this document**

**1.1 Function**  
This operating instructions manual provides all the information you need for the mounting, set-up and commissioning to ensure the safe operation and disassembly of the switchgear. The operating instructions must be available in a legible condition and a complete version in the vicinity of the device.

**1.2 Target group: authorised qualified personnel**  
All operations described in this operating instructions manual must be carried out by trained specialist personnel, authorised by the plant operator only.

Please make sure that you have read and understood these operating instructions and that you know all applicable legislations regarding occupational safety and accident prevention prior to installation and putting the component into operation.

The machine builder must carefully select the harmonised standards to be complied with as well as other technical specifications for the selection, mounting and integration of the components.

**1.3 Explanation of the symbols used**

 **Information, hint, note:**  
This symbol indicates useful additional information.

 **Caution:** Failure to comply with this warning notice could lead to failures or malfunctions.  
**Warning:** Failure to comply with this warning notice could lead to physical injury and/or damage to the machine.

**1.4 Appropriate use**  
The Schmersal range of products is not intended for private consumers.

The products described in these operating instructions are developed to execute safety-related functions as part of an entire plant or machine. It is the responsibility of the manufacturer of a machine or plant to ensure the correct functionality of the entire machine or plant.

The product must be exclusively used in accordance with the versions listed below or for the applications authorised by the manufacturer. Detailed information regarding the range of applications can be found in the chapter "Product description".

**1.5 General safety instructions**  
The user must observe the safety instructions in this operating instructions manual, the country specific installation standards as well as all prevailing safety regulations and accident prevention rules.

 Further technical information can be found in the Schmersal catalogues or in the online catalogue on the Internet: [products.schmersal.com](https://products.schmersal.com).

The information contained in this operating instructions manual is provided without liability and is subject to technical modifications.

There are no residual risks, provided that the safety instructions as well as the instructions regarding mounting, commissioning, operation and maintenance are observed.

### 1.6 Warning about misuse



In case of inadequate or improper use or manipulations of the component, personal hazards or damage to machinery or plant components cannot be excluded.

### 1.7 Exclusion of liability

We shall accept no liability for damages and malfunctions resulting from defective mounting or failure to comply with this operating instructions manual. The manufacturer shall accept no liability for damages resulting from the use of unauthorised spare parts or accessories.



For safety reasons, invasive work on the device as well as arbitrary repairs, conversions and modifications to the device, in particular to the switch insert or plunger, are strictly forbidden, the manufacturer shall accept no liability for damages resulting from such invasive work, arbitrary repairs, conversions and/or modifications to the device.

## 2. Product description

### 2.1 Ordering code

This operating instructions manual applies to the following types:

EX-T① 335-②Y-③-④

No.	Option	Description
①		Actuator selection, refer to catalogue
②	11	1 NO / 1 NC
	02	2 NC
③	2138	Roller lever 7H for safety applications
④	RMS	Brass actuating roller



In accordance with the Machinery Directive, the type plate of safety components is type plate is labelled "safety component".

Only if the information described in this operating instructions manual are realised correctly, the safety function and therefore the compliance with the Machinery Directive and the Explosion Protection Directive is maintained.

### 2.2 Special versions

For special versions, which are not listed in the order code below 2.1, these specifications apply accordingly, provided that they correspond to the standard version.

### 2.3 Purpose

The position switches are suitable for sliding and hinged guards, which need to be closed in order to ensure the required operational safety.

The components can be used in potentially explosive atmospheres of Zone 1 and 21 equipment category 2GD. The installation and maintenance requirements to the standard series 60079 must be met.



The user must evaluate and design the safety chain in accordance with the relevant standards and the required safety level.



The entire concept of the control system, in which the safety component is integrated, must be validated to the relevant standards.



The safety-technical data and features according to the applicable test certificate (or possible other approvals) are mentioned in the technical data.

### 2.4 Technical Data

Designation in accordance with the ATEX Directive:	⊕ II 2G ⊕ II 2D
Designation in accordance with standards:	Ex db eb IIC T6 Gb Ex tb IIIC T80°C Db
Applied standards:	EN 60947-5-1
- ATEX:	EN IEC 60079-0, EN 60079-1, EN IEC 60079-7, EN 60079-31
- IECEx:	IEC 60079-0, IEC 60079-1, IEC 60079-7, IEC 60079-31
- INMETRO:	ABNT NBR IEC 60079-0, ABNT NBR IEC 60079-1, ABNT NBR IEC 60079-7, ABNT NBR IEC 60079-31
- CCC-Ex, NEPSI:	GB/T 3836.1, GB/T 3836.2, GB/T 3836.3, GB/T 3836.31
Certificate numbers:	
- ATEX:	BVS 09 ATEX E 152
- IECEx:	BVS 10.0040
- INMETRO:	DNV 14.0041
- CCC-Ex:	2020322304002719
- NEPSI:	GYJ19.1291X
Enclosure:	zinc die-cast, paint finish
Design:	EN 50041
Design according to EN ISO 14119:	1
Max. impact energy:	7 J
Actuating speed:	max. 1 m/s
Degree of protection:	IP65
Contact material:	Silver
Contact type:	change-over with double break Zb, or 2 NC contacts, galvanically separated contact bridges
Switching system:	⊖ EN 60947-5-1, slow action, NC contact with positive break
Connection:	screw terminals
Cable section (screw clamp):	1 ... 2.5 mm <sup>2</sup> (with conductor ferrules)
Potential equalisation:	ring cable lug for M5 thread
Cable entry:	M20 x 1.5
Rated impulse withstand voltage U <sub>imp</sub> :	4 kV
Rated insulation voltage U <sub>i</sub> :	250 V
Thermal test current I <sub>the</sub> :	5 A
Utilisation category:	AC-1, AC-15, DC-13
Max. fuse rating:	6 A gG D-fuse
Required short-circuit current:	1,000 A
Ambient temperature:	
- cable section 2.5 mm <sup>2</sup>	-20 °C ... +55 °C
- cable section 1 mm <sup>2</sup>	-20 °C ... +50 °C
Mechanical life:	1 million operations
Max. switching frequency:	1,800/h
Bounce duration:	< 3 ms
Switchover time:	in accordance with actuating speed
Cable cross-section of the cable glands:	Ø 7 ... 12 mm
Cable glands:	⊕ II 2GD
Tightening torque:	
- Switch insert:	1.2 N
- Cover screws:	1.4 Nm
- Head screws:	1.5 Nm
- Screwed cable gland/Cap nut:	10 Nm
- Earth screw:	1 Nm



Maximum ambient temperature: 55°C.

The power-source has to be an isolated limited voltage/limited current protected by maximum 30Vdc, 4A (42.4Vdc peak).

### 2.5 Safety classification

Standards:	EN ISO 13849-1
B <sub>10D</sub> (NC contact):	20,000,000
B <sub>10D</sub> (NO contact) at 10% ohmic contact load:	1.000.000
Mission time:	20 years

$$MTTF_D = \frac{B_{10D}}{0,1 \times n_{op}} \quad n_{op} = \frac{d_{op} \times h_{op} \times 3600 \text{ s/h}}{t_{cycle}}$$

(Determined values can vary depending on the application-specific parameters h<sub>op</sub>, d<sub>op</sub> and t<sub>cycle</sub> as well as the load.)

### 3. Mounting

#### 3.1 General mounting instructions



Fitting is only authorised in a de-energised condition

The enclosure can be fixed by means of 4 mounting holes. The mounting dimensions are mentioned at the rear of the enclosure. The fixing screws must be protected against unauthorised tampering. The use of a protective ground wire is imperative. The enclosure must not be used as an end stop. Any mounting position.

To ensure a proper functioning, the switch must be installed so that the required switch travel is obtained. For safety functions, at least the positive break travel indicated in the switch travel diagram (refer to catalogue) must be obtained. All components have sufficient after-travel to compensate for inaccuracies in the guidance of the actuating system. The actuation of the switch beyond its end stop however must be avoided.



Please observe the recommendations regarding maximum impact energy, actuating speed and tightening torque in the technical data.



Please observe the remarks of the standards EN ISO 12100, EN ISO 14119 and EN ISO 14120.

#### 3.2 Dimensions

All measurements in mm.

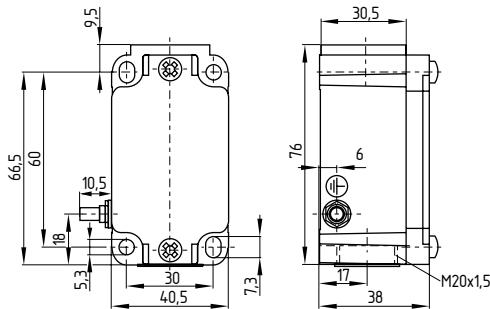

#### 3.3 Settings

##### Changing the switching function (4VH, 4V7H, 4V10H)

Position switches with "4V" actuating head can be set so that they are switched either only clockwise, only counterclockwise or in both directions. The following steps are required:

1. Unscrew the retaining screws and remove the actuating head
2. Change the position of both inner plastic parts
3. Replace the actuating head and tighten the screws
4. Tightening torque for the head screws: 1.5 Nm

switching in both directions

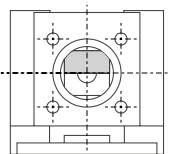

switching only clockwise

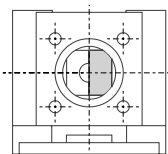

switching only counterclockwise

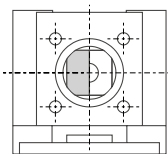

#### 3.4 Mounting of the actuating heads

##### Positioning actuator head (only for H, 10H, 7H, 7H-2138)

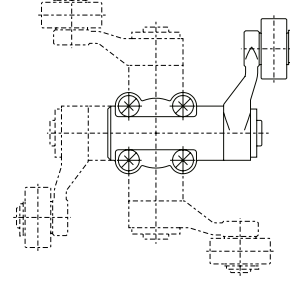

The actuating head can be repositioned by 4 x 90°. Unscrew the four screws of the actuating head (Philips tip profile), reposition the actuating head in the desired position and retighten the four screws (tightening torque 1.5 Nm).

##### Repositioning the roller lever (H)

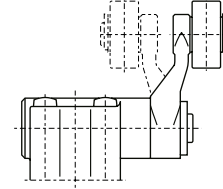

The (offset) roller arm may be reversed, so that the roller faces the inside of the arm.

##### Positioning the lever (.H)

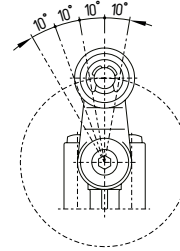

The roller lever can be repositioned over 360° on the toothed shaft in 10° steps. Unscrew the hexagonal screw approx. 4 mm, reposition the lever in the desired position and retighten the screw.

##### Length-adjustable lever (7H, 10H)

To adjust the length of the lever, unscrew the fixing screw of the lever. Firmly retighten the screw after the length adjustment.



Position switches with 7 H or 10 H actuator are not suitable for safety functions. Ordering suffix for actuator 7H with positive break: -2138.

### 4. Electrical connection

#### 4.1 General information for electrical connection



The electrical connection may only be carried out by authorised personnel in a de-energised condition.



The device cover, which must be removed for electrical connection, must be screwed back onto the same device after wiring.  
The same eight-digit numerical sequence is applied to the two labels for the respective production batch for identification purposes.

The contact labelling can be found in the wiring compartment of the switch.

Do not install cable loops in the inside space of the enclosure. Bare wires must not protrude beyond the clamping disc. Lead the cable insulation up to the clamping disc. All screws and/or nuts of the terminals, also the unused, must be screwed tight.

Settle length  $x$  of the conductor: 6 mm



Cable glands (included in delivery) are only authorised for permanent cables. The constructor must provide for the necessary strain relief. After wiring, dust and soiling must be removed from the wiring compartment.

After wiring, the cover screws must be tightened uniformly (Tightening torque cover screws: 1.4 Nm).



The external protective conductor terminal is to be connected in accordance with EN 60079-14 section 6.3. A ring tongue size M5 must be used to connect the protective conductor.

#### 4.2 Contact Options

Contacts are shown with safety guard closed.

##### 1 NO / 1 NC

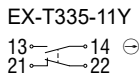

##### 2 NC

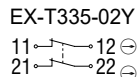

### 5. Set-up and maintenance

#### 5.1 Functional testing

The safety function of the safety components must be tested. The following conditions must be previously checked and met:

- The installation is executed according to the instructions.
- The connection is executed correctly.
- The cable is correctly executed and connected.
- Check the free movement of the actuating element.
- The safety component is not damaged.
- Remove particles of dust and soiling.
- Check cable entry and connections in de-energised condition.

#### K.A. Schmersal GmbH & Co. KG

Mödinghofe 30, 42279 Wuppertal  
Germany  
Phone: +49 202 6474-0  
Telefax: +49 202 6474-100  
E-Mail: info@schmersal.com  
Internet: www.schmersal.com

#### 5.2 Maintenance

In case of correct installation in accordance with the instructions described above, the component requires little maintenance. For use in extreme conditions, we recommend routine maintenance including the following steps:

1. Check the correct fixing of the actuator and the safety switchgear.
2. Lubricate the shaft or plunger
3. Remove particles of dust and soiling
4. Check cable entry and connections in a de-energised condition



Do not open the device when live.



Throughout the operative life cycles of the safety switchgear, suitable constructive and organisational measures are to be taken to prevent against tampering and to prevent the safety device being overridden.

**For explosion protection reasons, the component must be exchanged after max. 1 million operations.**

**Damaged or defective components must be replaced.**

### 6. Disassembly and disposal

#### 6.1 Disassembly

The safety switchgear must be disassembled in a de-energised condition only.

#### 6.2 Disposal



The safety switchgear must be disposed of in an appropriate manner in accordance with the national prescriptions and legislations.

### 7. Declaration of conformity

We hereby certify that the hereafter described components both in their basic design and construction conform to the applicable European Directives.

#### Relevant Directives:

2006/42/EC  
2014/34/EU  
2011/65/EU

#### Applied standards:

EN 60947-5-1:2017 + AC:2020  
EN IEC 60079-0:2018  
EN 60079-1:2014  
EN IEC 60079-7:2015 + A1:2018  
EN 60079-31:2014

#### Notified body for the prototype test:



DEKRA Testing and Certification GmbH  
Dinnendahlstraße 9  
44809 Bochum  
ID n°: 0158

#### Prototype test certificate:

BVS 09 ATEX E 152



The currently valid declaration of conformity can be downloaded from the internet at [products.schmersal.com](http://products.schmersal.com).