



EN Operating instructions. pages 1 to 10
Original

4 Electrical connection
4.1 Wiring example SLB240 7
4.2 Connector configuration Receiver, Emitter & Cable 8

5 Set-up and maintenance
5.1 Check before start-up 8
5.2 Maintenance 8
5.3 Regular check 8
5.4 Half-yearly inspection 8
5.5 Cleaning 8

6 Diagnostic
6.1 Indication of configuration when system starts 9
6.2 Status display 9
6.3 Error indication 9

7 Disassembly and disposal
7.1 Disassembly 9
7.2 Disposal. 9

8 Appendix
8.1 Contact 9

9 EU Declaration of conformity

Content

1 About this document
1.1 Function. 1
1.2 Target group: authorised qualified personnel 1
1.3 Explanation of the symbols used. 1
1.4 Appropriate use. 1
1.5 General safety instructions 2
1.6 Warning about misuse. 2
1.7 Exclusion of liability. 2

2 Product description
2.1 Purpose and use 2
2.2 Ordering code 2
2.3 Special versions 2
2.4 Included in delivery 2
2.5 Technical data 2
2.6 Response time (reaction time) 3
2.7 Safety classification. 3
2.8 Modes of operation / functions 3
2.8.1 Protection mode with automatic (automatic). 3
2.8.2 Protection mode with restart interlock 3
2.8.3 Test input. 3
2.8.4 Parameter setting 3
2.8.5 Self-test. 4

3 Mounting
3.1 General conditions 4
3.2 Protection field and approach 4
3.3 Aligning the sensors 4
3.4 Alignment mode 4
3.5 Safety distance 5
3.5.1 Minimum distance to reflecting surfaces 5
3.6 Interference / Beam coding 6
3.7 Dimensions 6
3.8 Mounting material (not included in delivery) 6

1. About this document

1.1 Function

This operating instructions manual provides all the information you need for the mounting, set-up and commissioning to ensure the safe operation and disassembly of the safety device. The operating instructions must be available in a legible condition and a complete version in the vicinity of the device.

1.2 Target group: authorised qualified personnel

All operations described in this operating instructions manual must be carried out by trained specialist personnel, authorised by the plant operator only.

Please make sure that you have read and understood these operating instructions and that you know all applicable legislations regarding occupational safety and accident prevention prior to installation and putting the device into operation.

The machine builder must carefully select the harmonised standards to be complied with as well as other technical specifications for the selection, mounting and integration of the components.

1.3 Explanation of the symbols used



Information, hint, note:

This symbol is used for identifying useful additional information.



Caution: Failure to comply with this warning notice could lead to failures or malfunctions.

Warning: Failure to comply with this warning notice could lead to physical injury and/or damage to the machine.

1.4 Appropriate use

The Schmersal range of products is not intended for private consumers.

The products described in these operating instructions are developed to execute safety-related functions as part of an entire plant or machine. It is the responsibility of the manufacturer of a machine or plant to ensure the correct functionality of the entire machine or plant.

The safety device must be exclusively used in accordance with the versions listed below or for the applications authorised by the manufacturer. Detailed information regarding the range of applications can be found in the chapter "Product description".

1.5 General safety instructions

The user must observe the safety instructions in this operating instructions manual, the country-specific installation standards as well as all prevailing safety regulations and accident prevention rules.



Further technical information can be found in the Schmersal catalogues or in the online catalogue on the Internet: products.schmersal.com.

The information contained in this operating instructions manual is provided without liability and is subject to technical modifications.

There are no residual risks, provided that the safety instructions as well as the instructions regarding mounting, commissioning, operation and maintenance are observed.

Additional measures could be required to ensure that the system does not present a dangerous breakdown, when other forms of light beams are available in a special application (e.g. use of wireless control devices on cranes, radiation of welding sparks or effects of stroboscopic lights).

1.6 Warning about misuse



In case of improper use or manipulation of the safety switchgear, personal hazards or damages to machinery or plant components cannot be excluded when safety device is used.



Only if the information described in this operating instructions manual are realised correctly, the safety function and therefore the compliance with the Machinery Directive is maintained.

1.7 Exclusion of liability

We shall accept no liability for damages and malfunctions resulting from defective mounting or failure to comply with this operating instructions manual. The manufacturer shall accept no liability for damages resulting from the use of unauthorised spare parts or accessories.

For safety reasons, invasive work on the device as well as arbitrary repairs, conversions and modifications to the device are strictly forbidden; the manufacturer shall accept no liability for damages resulting from such invasive work, arbitrary repairs, conversions and/or modifications to the device.

2. Product description

2.1 Purpose and use

The SLB is a non-contact, self-testing safety device, which is used for the protection of hazardous points, hazardous areas and machine access. If one or more light beams are interrupted, the hazardous movement must be stopped.



The user must evaluate and design the safety chain in accordance with the relevant standards and the required safety level.



The entire concept of the control system, in which the safety component is integrated, must be validated to the relevant standards.

2.2 Ordering code

This operating instructions manual applies to the following types:

SLB240-ER-①-②

| No. | Option | Description |
|-----|--------|----------------------------|
| ① | 1 | Beam coding 1 |
| | 2 | Beam coding 2 |
| | 3 | Beam coding 3 |
| | 4 | Beam coding 4 |
| ② | ST | Termination male connector |
| | LST | Cable with connector |

2.3 Special versions

For special versions, which are not listed in the order code, these specifications apply accordingly, provided that they correspond to the standard version.

2.4 Included in delivery

Emitter, receiver, operating instructions DE/EN

2.5 Technical data

Standards: EN 61496-1; EN 61496-2; EN ISO 13849-1; EN 62061

Material of the enclosure: Aluminium

Detection ability for test bodies: 10 mm static ¹⁾

SLB range: 0.3 ... 15.0 m

Reaction time:

| | |
|--|-------|
| - Beam coding 1, impulse pattern 1, 5 samplings: | 10 ms |
| - Beam coding 2, impulse pattern 2, 5 samplings: | 14 ms |
| - Beam coding 3, impulse pattern 3, 5 samplings: | 18 ms |
| - Beam coding 4, impulse pattern 4, 5 samplings: | 22 ms |
| - Beam coding 5, impulse pattern 1, 3 samplings: | 7 ms |

Rated operating voltage: 24 VDC ± 10%, 1 A

PELV mains unit in accordance with EN 60204 (power failure bypass 20 ms)

Rated operating current: 100 mA + 200 mA each OSSD

Wavelength of the infrared radiation: 880 nm

Emitter, infrared emitted radiation

- to EN 12198-1: Category 0

- to EN 62471: free group

Safety outputs

OSSD1, OSSD2: 2 x short-circuit proof PNP semi-conductor outputs

Test impulse cycle OSSD: 600 ms

Test impulse length: max. 200 µs

Switching voltage HIGH ²⁾: >15 V

Switching voltage LOW ²⁾: <2 V

Switching current each OSSD: 200 mA

Leakage current ³⁾: <1 mA

Load capacity: max. 200 nF

Load inductance ⁴⁾: max. 2 H

Inputs:

- Restart: 100 ms to 1500 ms monitored

- Test: 20 ms up to 10 s, monitored

Input Test LOW: Switching off emitter = 8 ms

Input Test HIGH: Switch-on output = 92 ms

Function: Protective mode / Automatic,

Restart Interlock (manual reset), Setting mode

Status indication receiver: End cap with integrated status indication

Connection:

- Emitter: connector M12, 4-pole

- Receiver: connector M12, 5-pole

Ambient temperature: -30° C ... + 50° C

Storage temperature: -30° C ... + 70° C

Degree of protection: IP67 (EN 60529)

Resistance to vibration: 10 ... 55 Hz to EN 60068-2-6

Resistance to shock: 10 g, 16 ms, to EN 60028-2-29

Weight: SLB240-ST: 0,14 kg, SLB240-LST: 0,15 kg

Year of construction: as of 2016 version 1.0

- ¹⁾ Detection capability is reduced with moving test body. Further information available from technical sales department.
- ²⁾ To EN 61131-2
- ³⁾ In case of failure, OSSD leakage current.
The downstream control element must recognise this state as LOW. A safety PLC must detect this state.
- ⁴⁾ The load inductivity generates an induced voltage during the switch-off, which compromises the downstream components (spark quenching element).

2.6 Response time (reaction time)

The response time depends on the number of light beams and the beam coding A.

| Beam coding | Response time [ms] |
|-------------|--------------------|
| 1 | 10 |
| 2 | 14 |
| 3 | 18 |
| 4 | 22 |
| 5 | 7 |

2.7 Safety classification

| | |
|-------------------|--------------------------|
| Standards: | EN ISO 13849-1, EN 62061 |
| PL: | up to c |
| Control category: | up to 2 |
| PFH: | 1.5×10^{-8} 1/h |
| SIL: | up to 1 |
| Mission time: | 20 years |

2.8 Modes of operation / functions

All of the described functions can be executed without safety monitoring modules. A command unit is needed for diagnosis and function selection (button, adapter cable, see section on parameterisation).

The system has the following operating modes:

- Protection mode with automatic start after release of the protection field (factory setting)
- Protection mode with restart interlock

The system has the following functions:

- Parameter setting with selection of beam coding and type of protection mode.
- Alignment aid, diagnosis

Factory setting

When delivered (factory setting) automatic mode is active.

2.8.1 Protection mode with automatic (automatic)

In automatic mode the safety switching outputs (OSSD) are switched to the ON state if the protection zone is uninterrupted. This is done without any authorization from a command device.

This operating mode initiates an automatic restart of the machine if the protection zone is not interrupted.



This operating mode may only be chosen in conjunction with the restart interlock (manual reset) of the machine. This operating mode must not be chosen, when persons can step behind the protection field.

Display

| Diagnostic lamp | Status |
|-----------------|--|
| Red | OFF state (protection zone interrupted, OSSD signal low) |
| Green | ON state (protection zone uninterrupted, OSSD signal high) |

2.8.2 Protection mode with restart interlock

In the operating mode restart interlock, the safety switching outputs (OSSD) remain in the OFF condition after the power supply is applied or after the protection zone has been interrupted.

The AOPD switches the OSSDs to the ON state once the restart input signal impulse is applied with a duration of $100 \text{ ms} < T < 1500 \text{ ms}$ using a command device (push button).

The receiver indicates the readiness for authorized operation with a yellow signal on the end cap. If the protection zone is interrupted, the signal will indicate red.



The AOPD changes to alignment aid mode if the enabling button is pressed for at least 2 seconds when the operating voltage is applied, see chapter Alignment aid.



The command device (enabling button) must be installed outside of the hazardous area. The hazardous zone must be easily visible to the user.

Display

| Diagnostic lamp | Status |
|-----------------|--|
| Red | OFF state (protection zone interrupted, OSSD signal low) |
| Green | ON state (OSSD signal high) |
| Yellow | Restart interlock is active, SLB waiting for enabling signal |

2.8.3 Test input

The AOPD has a machine test function. The test input is provided for periodic test by a safety related control system. Connecting the input to 0 V switches off the safety device and receiver outputs are switched to the OSSD OFF-state. For machine test duration longer than 150 ms a restart interlock function needs to be provided.

2.8.4 Parameter setting

In parameterisation mode, individual adaptation of the operating parameters for emitter and receiver can be carried out.

Possible options are:

| No. | Option | Description |
|-----|---------------------|--|
| P1 | active / not active | Beam coding 1 (response time 10 ms) |
| P2 | active / not active | Beam coding 2 (response time 14 ms) |
| P3 | active / not active | Beam coding 3 (response time 18 ms) |
| P4 | active / not active | Beam coding 4 (response time 22 ms) |
| P5 | active / not active | Beam coding 5 (response time 7 ms) |
| P6 | active / not active | active = restart interlock not active= automatic mode |



The beam coding 5 may only be used if no other SLBs are operated in parallel.



The response time of the system changes with the selected beam coding. The safety distance must be adapted accordingly. See section on reaction time.

Parameter setting with adapter cable KA-0977

- Switch the supply voltage off.
- Connect adapter cable KA-0977 to the device.
- Press and hold the integrated button and switch the supply voltage on. The button can be released as soon as the indicator of the receiver changes from red to yellow and the indicator of the emitter changes from blue to yellow.
- The AOPD is now in setup mode. The signal strength is displayed on the receiver through impulses or steady illumination of the yellow LEDs.
- To change to parameterisation, the button must be pressed briefly ($100\text{ ms} < T < 1500\text{ ms}$).
- The status of parameter P1 is now indicated. The signal lamp lights up once in cyan (parameter is active) or magenta (parameter is not active).
- Press the button briefly to change to the next parameter. The number of light impulses indicates the parameter number, the colour indicates the parameter status (cyan = active, magenta = not active).
- Press and hold the button ($2.5\text{ s} < T < 6\text{ s}$) and the status of the current parameter changes from ACTIVE to NOT ACTIVE or from NOT ACTIVE to ACTIVE and is saved. While the button is pressed, the indicator changes after 1.5 s to a static indication of the current parameter setting. Pressing and holding the button longer $T > 2.5\text{ s}$ indicates the colour of the new status. The button can now be released to save. If the button is pressed and held for longer than 6 s, the indicator goes out and the change is not accepted.
- To exit parameterisation mode, switch the supply voltage off and restore the original wiring.



Emitters and receivers can be configured simultaneously with adapter cable KA-0977.



Parameter P6 restart interlock only acts on the receiver. The parameter is only indicated on the emitter.

Parameter setting without adapter cable KA-0977

As an alternative to the adapter cable, a button can be connected as follows:

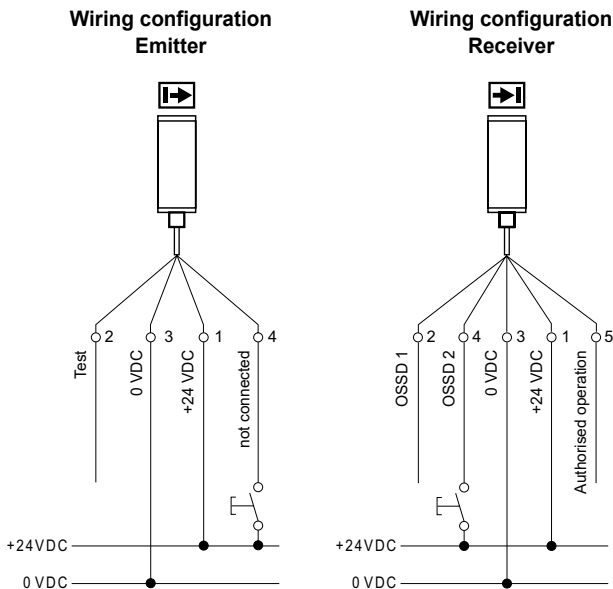

2.8.5 Self-test

The AOPD carries out a self-test within 2 seconds after the power supply is applied. In the event of a fault, the AOPD is locked in the OFF state and reports the status (see section on fault diagnosis).

After a successful self-test the AOPD switches to the ON state if the protection zone is clear (automatic operating mode).

During operation, the system executes a cyclic self-test. Safety-relevant faults are detected within the reaction time and cause the outputs to be put in the OFF state and an error code is indicated.

3. Mounting

3.1 General conditions

The following guidelines are provided as preventive warning notices to ensure a safe and appropriate handling. These guidelines are an essential part of the safety instructions and therefore must always be observed and respected.



- The AOPD must not be used on machines which cannot be stopped electrically in case of emergency.
- The safety distance between the AOPD and a hazardous machine movement must always be observed.
- Additional mechanical safety guards must be installed so that the operator has to pass by the protection field to reach the hazardous machine parts.
- The AOPD must be installed so that the personnel is always within the detection zone when operating the machine. An incorrect installation can lead to serious injuries.
- Never connect the outputs to +24VDC. If the outputs are wired to +24VDC, they are in ON state, as a result of which they are unable to stop a hazardous situation occurring on the application/machine.
- The safety inspections must be conducted regularly.
- The AOPD must not be exposed to inflammable or explosive gasses.
- The connecting cables must be connected in accordance with the installation instructions.
- The fixing screws of the end caps and the mounting angle must be firmly tightened.

3.2 Protection field and approach

Additional protective devices must ensure that the operator has to pass by the protection field to reach the hazardous machine parts. The AOPD must be installed so that personnel are always located within the detection zone of the safety device when operating the hazardous machine parts to be secure.

3.3 Aligning the sensors

Procedure:

1. Emitter and receiver must be fitted parallel to each other and at the same height.
2. First turn the emitter and then the receiver so that the front covers are opposite each other until the integrated signal lamp lights up green (operating mode automatic) or yellow (operating mode restart interlock).
3. Adjust the emitter and receiver so that they are in the middle of the angular range for a green or yellow indication. Fix the position with the two screws for the mounting bracket.

3.4 Alignment mode

In this operating mode, the signal strength is indicated by yellow light impulses. The better the alignment, the higher the frequency of the light pulses. The alignment is optimal when the light pulses switch over to continuous light.

If there is no optical synchronisation between the emitter and the receiver, a light pulse is emitted every three seconds.

Alignment mode is terminated by switching off the supply voltage.

Activating alignment mode with 5-pole cable connection

If through power-up 24V is applied to the restart input via a pushbutton for at least 2 seconds the device will start in alignment mode. The push button can be released as soon as the indicator changes from red to yellow.

Activating setup mode with 4-pole cable connection

If +24V is applied for at least 2 seconds when the system starts at the "OSSD 1" output, the receiver unit starts in alignment mode.



If setup mode is activated with 24V at OSSD 1, the outputs OSSD 1 and OSSD 2 must not be connected to the machine or the machine controls.

Activating setup mode with adapter cable KA-0977

Connect the adapter cable to the device. Press and hold the integrated button and switch the supply voltage on. The button can be released as soon as the indicator changes from red to yellow.

3.5 Safety distance

The safety distance is the minimum distance between the protection field of the safety light barrier and the hazardous area. The safety distance must be observed to ensure that the hazardous area cannot be reached before the hazardous movement has come to standstill.

Calculation of the safety distance to EN ISO 13855 and EN ISO 13857

The safety distance depends on the following elements:

- Stopping time of the machine (calculation by run-on time measurement)
- Response time of the machine and the safety light barrier and the downstream safety-monitoring module (entire safety guard)
- Approach speed

Safety light barrier

The safety distance for the safety light barrier is calculated by means of the following formula:

$$S = (1600 \text{ mm/s} \times T) + 1200 \text{ [mm]}$$

S = Safety distance [mm]

T = Total reaction time (machine run-on time, reaction time of the safety guard, relays, etc.)

To prevent the AOPD from reaching over or creeping under, the beam should be installed 750 mm above the ground or reference level (see EN ISO 13857).

If using safety light barriers, the following points must be observed:

- Prevent the possibility of going under or over the beam
- Prevent the possibility of reaching through between two beams
- Prevent the possibility of climbing through between two beams

Safety distance to the hazardous area

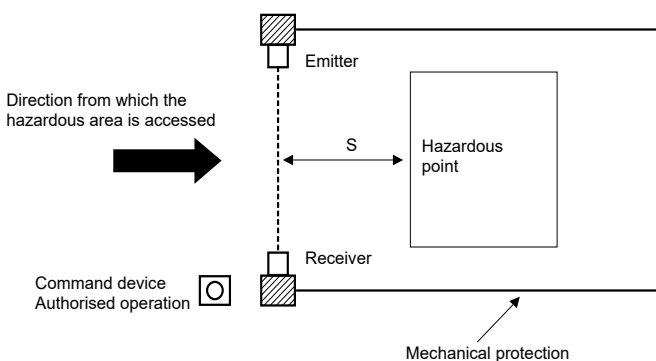

Please observe the applicable harmonised standards and possible applicable national regulations.



The safety distance between the safety light barrier and the hazardous point must always be respected and observed. If a person reaches the hazardous point before the hazardous movement has come to a standstill, he or she is exposed to serious injuries.



The AOPD should be located parallel with the floor and the beam should be interrupted by the upright body of a person. A single beam AOPD as the only guard system is not suitable for preventing the whole body of a person from accessing. We recommend combining the AOPD with other protective equipment to make it impossible to pass by the guard system without being detected in the process. The AOPD can not be used as finger or hand protection.



To calculate the minimum distances of the safety guards with regards to the hazardous point, the EN ISO 13855 and EN ISO 13857 must be observed.

3.5.1 Minimum distance to reflecting surfaces

During the installation, the effects of reflecting surfaces must be taken into account. In case of an incorrect installation, interruptions of the protection field could possibly not be detected, which could lead to serious injuries. The hereafter-specified minimum distances with regard to reflecting surfaces (metal walls, floors, ceilings or parts) must be imperatively observed.

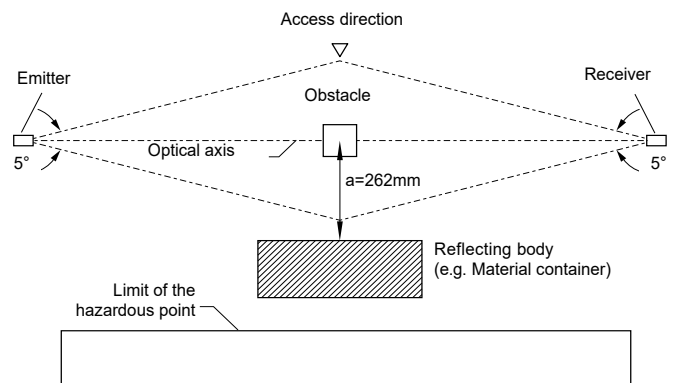

Minimum distance a

Calculate the minimum distance to reflecting surfaces as a function of the distance with an aperture angles of $\pm 5^\circ$ degrees or use the value from the table below:

| Distance between emitter and receiver [m] | Minimum distance a [mm] |
|---|-------------------------|
| 0.2 ... 3.0 | 262 |
| 4 | 350 |
| 5 | 440 |
| 7 | 620 |
| 10 | 880 |
| 12 | 1060 |

$$\text{Formula: } a = \tan 5^\circ \times L \text{ [mm]}$$

a = Minimum distance to reflecting surfaces

L = Distance between emitter and receiver

3.6 Interference / Beam coding

If there is a risk of a receiver picking up the light signals from other emitters, each system must be operated with its own beam coding.

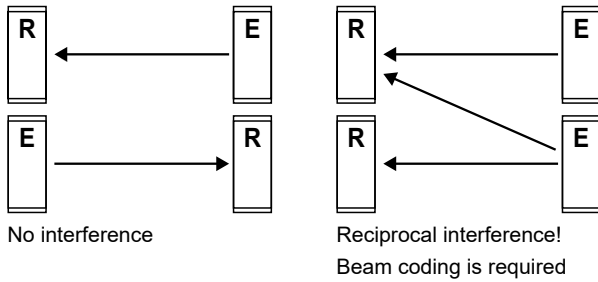

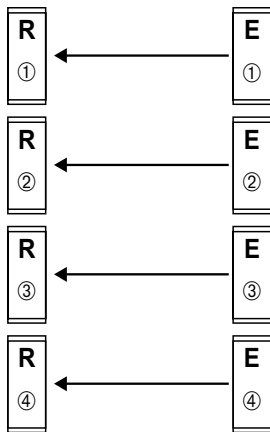

Four different beam codings can be set (see section on setting the parameters). The beam coding must be set in pairs (emitter and receiver).



 Reciprocal interference from systems is to be avoided by choosing suitable mounting positions or by configuring different beam codings.

 The user is at risk if systems are operated with reciprocal interference.

 The response time of the system changes with the selected beam coding. The safety distance must be adapted accordingly. See section on reaction time.

 When the system starts, the integrated signal lamp indicates the set beam coding by the corresponding number of light impulses.

 If an AOPD is operated with no other neighbouring systems, beam coding 5 with a very short reaction time (7 ms) can be selected.

3.7 Dimensions

Dimensions of emitter and receiver SLB240-ER-x-ST

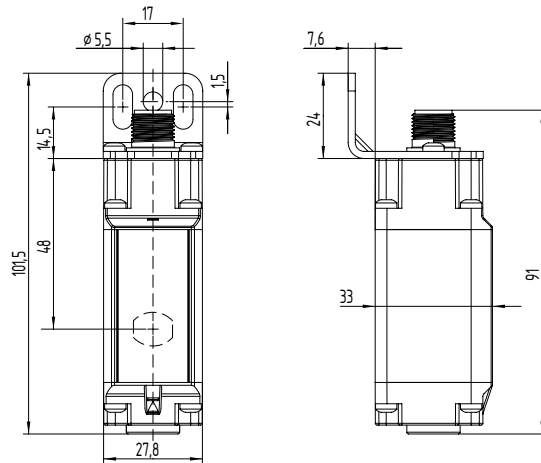

Dimensions of emitter and receiver SLB240-ER-x-LST

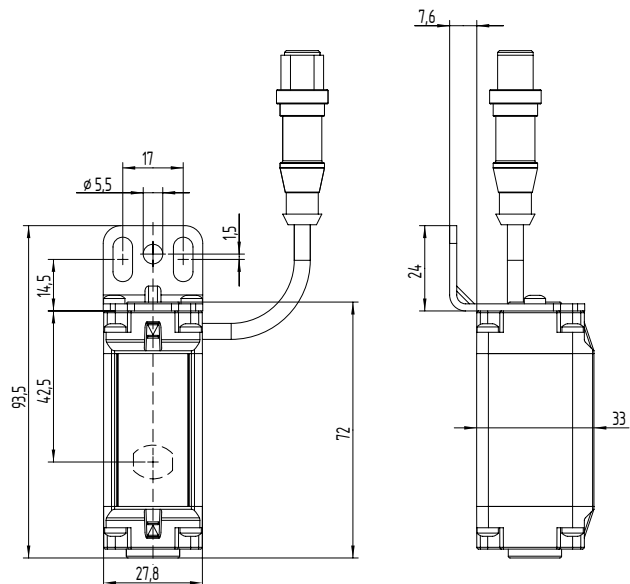

Cable with connector, length = 200 mm

3.8 Mounting material (not included in delivery)

Mounting kit MS-1101

The mounting kit consists of 2 steel angles and 4 fixing screws (Type Torx plus 10IP).

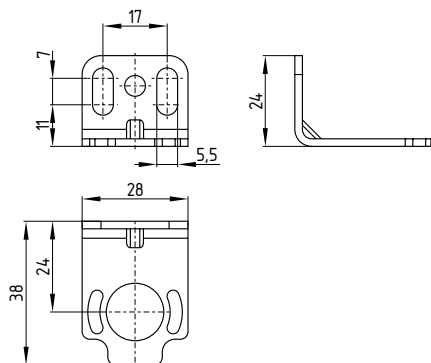

Connecting cable for emitter / receiver (4-pole)

| Item N° | Designation | Description | Length |
|-----------|-------------|------------------------------|--------|
| 101207741 | KA-0804 | Female connector M12, 4-pole | 5 m |
| 101207742 | KA-0805 | Female connector M12, 4-pole | 10 m |
| 101207743 | KA-0808 | Female connector M12, 4-pole | 20 m |

Adapter cable for parameter setting

| Item N° | Designation | Description | Length |
|-----------|-------------|--|--------|
| 103013625 | KA-0977 | Pushbutton with command device 1x male connector M12, 5-pole 2x female connector M12, 5-pole | 3 m |

Connecting cable for receiver (5-pole)*

| Item N° | Designation | Description | Length |
|-----------|---------------------------------|------------------------------|--------|
| 103010816 | A-K5P-M12-S-G-5M-BK-2-X-A-4-69 | Female connector M12, 5-pole | 5 m |
| 103010818 | A-K5P-M12-S-G-10M-BK-2-X-A-4-69 | Female connector M12, 5-pole | 10 m |
| 103010820 | A-K5P-M12-S-G-15M-BK-2-X-A-4-69 | Female connector M12, 5-pole | 15 m |

* For use in the operating mode Restart Interlock (manual reset)

4. Electrical connection

4.1 Wiring example SLB240

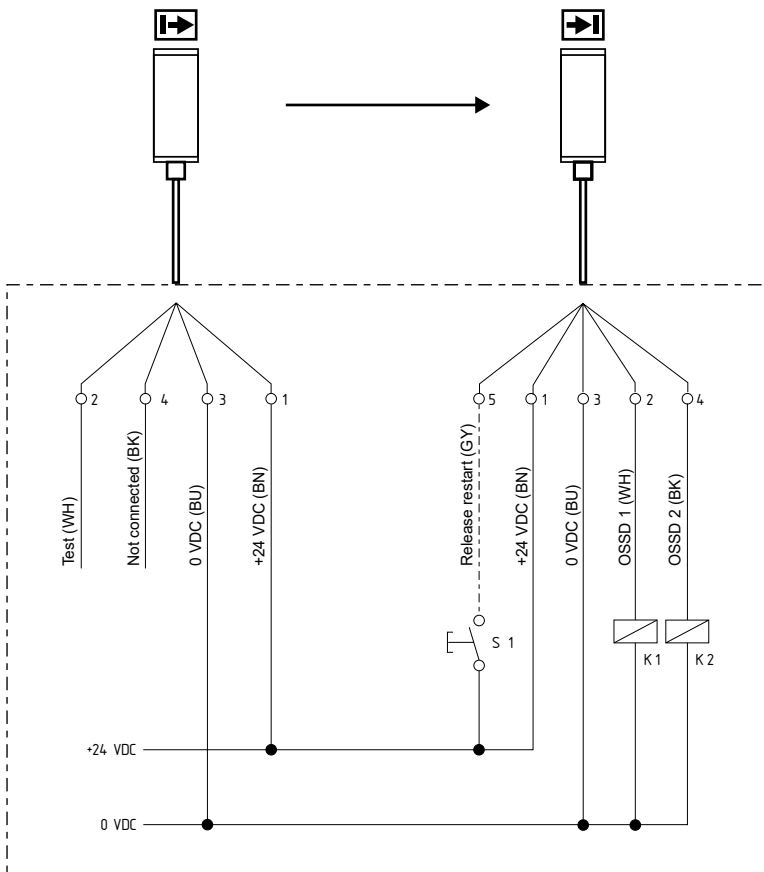

Protective mode / Automatic active:

Delivery state (Command device button S1 not connected)

Restart Interlock (manual reset) active:

Refer to the chapter: operating mode activate restart interlock (Command device button 1 connected)

- K1, K2: Relay for processing the switching outputs
OSSD 1, OSSD 2
- S1: Command device pushbutton for restart (optional)

4.2 Connector configuration Receiver, Emitter & Cable

EMITTER Connector

M12, 4-pole

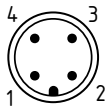

| PIN | Designation | Description |
|-----|-------------|--------------|
| 1 | +24 V | Power supply |
| 2 | Test | Test input |
| 3 | 0 V | Power supply |
| 4 | NC | Unassigned |

Connector female

M12, 4-pole

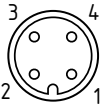

RECEIVER Connector

M12, 5-pole

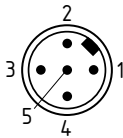

| PIN | Designation | Description |
|-----|-------------------|--|
| 1 | +24 V | Power supply |
| 2 | OSSD1 | Safety output 1 |
| 3 | 0 V | Power supply |
| 4 | OSSD2 | Safety output 2 |
| 5 | Restart interlock | Authorisation / restart (manual reset) |

Connector female

M12, 5-pole

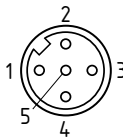

5. Set-up and maintenance

5.1 Check before start-up

Prior to start-up, the following items must be checked by the responsible person.

Wiring check prior to start-up

1. A 24V direct current power supply unit (see technical data) must be used for the voltage supply. A power downtime of 20 ms must be bridged.
2. Presence of a voltage supply with correct polarity at the AOPD.
3. The connecting cable of the emitter is correctly connected to the emitter and the connecting cable of the receiver correctly to the receiver.
4. The double insulation between the output and an external potential is assured.
5. The outputs OSSD1 and OSSD2 are not connected to +24 VDC.
6. The connected switching elements (load) are not connected to +24 VDC.
7. If two or more AOPDs are used within close range compared to each other, an alternating arrangement must be observed. Any mutual interference of the systems must be prevented.

Switch the AOPD on and check the operation in the following way:

The component performs a system test during approx. 2 seconds after the operating voltage has been switched on. The outputs are then enabled if the protection field is not interrupted. The status indication at the receiver is on.



In case of incorrect functionality, please follow the instructions listed in the chapter Fault diagnostic.

5.2 Maintenance



Do not use the AOPD before the next inspection has been completed. An incorrect installation can lead to serious and mortal injuries.

Conditions

For safety reasons, all inspection results must be archived. The operating principle of the AOPD and the machine must be known in order to be able to conduct an inspection. If the fitter, the planning technician and the operator are different persons, please make sure that the user has the necessary information at his disposal to be able to conduct the maintenance.

5.3 Regular check

A regular visual inspection and functional test, including the following steps, is recommended:

1. The component does not have any visible damages.
2. The optics cover is not scratched or soiled.
3. Hazardous machinery parts can only be accessed by passing through the protection zone of the AOPD.
4. The staff remains within the detection area, when works are conducted on hazardous machinery parts.
5. The safety distance of the application exceeds the mathematically calculated one.

Operate the machine and check whether the hazardous movement stops under the hereafter-mentioned circumstances.

1. Hazardous machine parts do not move when the protection field is interrupted.
2. The hazardous machine movement is immediately stopped, when the protection field is interrupted with the test rod immediately before the emitter, immediately before the receiver and in the middle between the emitter and the receiver.
3. No hazardous machine movement when the test rod is within the protection field.
4. The hazardous machine movement comes to standstill, when the voltage supply of the AOPD is switched off.

5.4 Half-yearly inspection

The following items must be checked every six months or when a machine setting is changed.

1. Machine stops or does not inhibit any safety function.
2. No machine modification or connection change, which affects the safety system, has taken place.
3. The outputs of the AOPD are correctly connected to the machine.
4. The total response time of the machine does not exceed the response time calculated during the first putting into operation.
5. The cables, the connectors, the caps and the mounting angles are in perfect condition.

5.5 Cleaning

If the optics cover of the sensors is extremely soiled, the OSSD outputs can be disabled. Clean with a clean, soft cloth with low pressure. The use of aggressive, abrasive or scratching cleaning agents, which could attack the surface, is prohibited.

6. Diagnostic

Emitters and receivers are equipped with an integrated signal lamp in the transparent end cap. The signal lamp indicates the operating status or, in the event of a fault, a fault code.



If there are no faults during operation, the status indicator on the emitter goes out after 10 minutes.

6.1 Indication of configuration when system starts

The emitters and receivers indicate the set beam coding once after 5 seconds when the system starts. A number of short light impulses are output in the process, which correlates with the number of the beam coding.



On the receiver, the indicator is delayed until there is no change in the ON state or OFF state of the OSSDs for 5 seconds.

6.2 Status display

| Emitter Display | Status |
|-----------------|---|
| Blue | Emitter operation, the indicator is switched off 10 minutes after start-up. |
| Yellow | Alignment mode |
| Red | Fault status, see section on fault indication |
| Cyan, magenta | Parameterisation mode, see section on parameter setting |

| Receiver Display | Status |
|-----------------------|--|
| Green | Status of OSSD safety switch outputs is ON, protection field is clear. |
| Yellow | Restart interlock is active, SLB waiting for enabling signal |
| Red | Status of OSSD safety switch outputs is OFF, protection field is not clear. |
| Red | Alternating OFF pulses signalise the fault status, see section on fault indicator. |
| Yellow, cyan, magenta | Parameterisation or setup mode, see section on parameterisation and setup mode. |

6.3 Error indication

If there is a fault, red stays on and the fault number is indicated by way of OFF impulses. The number of impulses indicates the number of the fault.

| Error number | Cause |
|--------------|--|
| 1 | Wiring fault, test signal >10 sec. |
| 2 | Voltage fault in power supply. |
| 3 | Voltage fault in safety output OSSD1 or OSSD2. |
| 5 | Incorrect configuration data. |
| 6 | Internal fault during self-test and diagnosis. |

7. Disassembly and disposal

7.1 Disassembly

The safety device must be disassembled in a de-energised condition only.

7.2 Disposal

The safety device must be disposed of in an appropriate manner in accordance with the national prescriptions and legislations.

8. Appendix

8.1 Contact

Consultancy / Sales:



K.A. Schmersal GmbH & Co. KG
 Möddinghofe 30
 42279 Wuppertal
 Germany
 Tel.: +49 202 6474-0
 Fax: +49 202 6474-100

You will also find detailed information regarding our product variety on our website: products.schmersal.com

Repair handling / shipping:

Safety Control GmbH
 Am Industriepark 2a
 84453 Mühldorf/Inn
 Germany
 Tel.: +49 8631 18796-0
 Fax: +49 8631 18796-1

9. EU Declaration of conformity

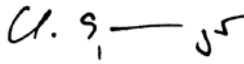
| EU Declaration of conformity | |  |
|--|---|--|
| Original | Safety Control GmbH Am Industriepark 2a 84453 Mühldorf / Inn Germany | |
| We hereby certify that the hereafter described components both in their basic design and construction conform to the applicable European Directives. | | |
| Name of the component: | SLB240 | |
| Type: | See ordering code | |
| Description of the component: | Safety light barriers | |
| Relevant Directives: | Machinery Directive EMC-Directive RoHS-Directive | 2006/42/EC 2014/30/EU 2011/65/EU |
| Applied standards: | EN 61496-1:2013, EN 61496-2:2013, EN ISO 13849-1:2015, EN 62061:2005 + Cor.:2010 + A1:2013 + A2:2015 | |
| Notified body for the prototype test: | TÜV NORD CERT GmbH Am TÜV 1, 45307 Essen ID n°: 0044 | |
| EC-prototype test certificate: | 44 205 16 019906 | |
| Person authorized for the compilation of the technical documentation: | Oliver Wacker Möddinghofe 30 42279 Wuppertal | |
| Place and date of issue: | Mühldorf, July 16, 2022 | |
| SLB240-B-EN |  |  |
| | Authorised signature Klaus Schuster Managing Director | Authorised signature Christian Spranger Managing Director |



The currently valid declaration of conformity can be downloaded from the internet at products.schmersal.com.

